

DENON

Hi-Fi Stereo Recorder

SERVICE MANUAL MODEL DMD-1000

STEREO MD RECORDER

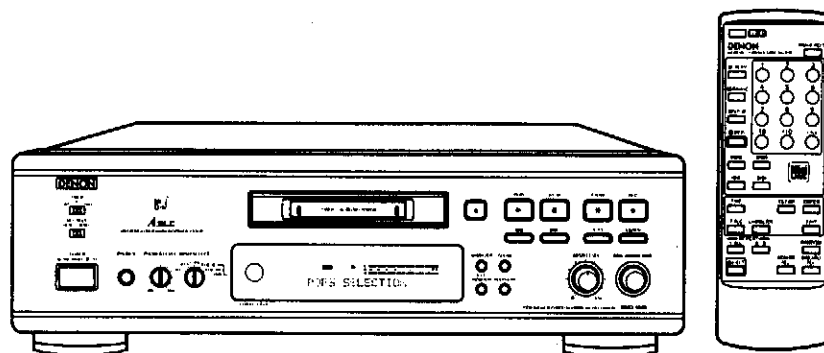

— TABLE OF CONTENTS —

OPERATING INSTRUCTION	2-14
DESASSEMBLY	15
ADJUSTMENT	16-26
BLOCK DIAGRAM	27
SEMICONDUCTORS	28-33
PRINTED WIRING BOARD PATTERNS	34,35
NOTE FOR PARTS LIST	36
PRINTED WIRING BOARD PARTS LIST	36-39
MDM97 MD MECHANISM P.W.B. UNIT ASS'Y PARTS LIST	40-42
PARTS LIST OF MDM97 MD MECHANISM	43
MDM97 MD MECHANISM EXPLODED VIEW	43
EXPLODED VIEW	44
PARTS LIST OF EXPLODED VIEW	45
WIRING DIAGRAM	46
SCHEMATIC DIAGRAM	47-50







● In order to explain clearly, some illustrations using in this service manual may be slightly different from the actual set.

NIPPON COLUMBIA CO., LTD.

OPERATING INSTRUCTIONS

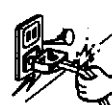
< Europe / U.K. & Asia Models >

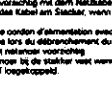
NOTE ON USE / HINWEISE ZUM GEBRAUCH / OBSERVATIONS RELATIVES A L'UTILISATION
ALVORENS TE GEBRUIKEN

 <ul style="list-style-type: none"> Avoid high temperatures Allow for sufficient heat dissipation when installed on a rack Vermijden Sie hohe Temperaturen Beschriften Sie, die sich ausreichend Luftzirkulation gewährleisten wird, wenn das Gerät auf ein Regal gesetzt wird Eviter des températures élevées Prevoir une dissipation de chaleur suffisante lors de l'installation sur une étagère Vermijd hoge temperaturen Zorg voor een genoeg afvoer van warmte indien het apparaat op een rek wordt geplaatst 	 <ul style="list-style-type: none"> Keep the set free from moisture, water, and dust. Halten Sie das Gerät von Feuchtigkeit, Wasser und Staub fern. Prévoir l'appareil contre l'humidité, l'eau et la poussière. Laat geen vochtigheid, water of stof in het apparaat binnen-dringen. 	 <ul style="list-style-type: none"> Do not let foreign objects in the set. Keine fremden Gegenstände in das Gerät kommen lassen. Ne pas laisser des objets étrangers dans l'appareil. Laat geen vreemde voorwerpen in dit apparaat vallen.
 <ul style="list-style-type: none"> Handle the power cord carefully Hold the plug when unplugging the cord. Greifen Sie vorsichtig mit dem Netzstecker an. Halten Sie das Kabel am Stecker, wenn Sie das Stecker hier ausziehen. Manipuler le cordon d'alimentation avec précaution Tenez le cordon lors du débranchement du cordon. Handeert het netstekker voorzichtig Houd het snoer bij de stekker vast wanneer deze moet worden sern- of losgekoppeld 	 <ul style="list-style-type: none"> Unplug the power cord when not using the set for long periods of time. Wenn das Gerät eine längere Zeit nicht verwendet werden soll, trennen Sie das Netzstecker vom Netzstecker. Débrancher le cordon d'alimentation lorsque l'appareil n'est pas utilisé pendant de longues périodes. Haem altijd het netstecker uit het aansluitpunt wanneer het apparaat gedurende een lange periode niet wordt gebruikt. 	 <ul style="list-style-type: none"> Do not let macadam, banana, and thinner come in contact with the set. Laassen Sie das Gerät nicht mit Insekten, Benzin oder Verdünnungsmitteln in Berührung kommen. Ne pas mettre en contact des macadam, du benzène et un diluant avec l'appareil. Laat geen meststoffen, benzine of verfverdunder met dit apparaat in contact komen.
 <ul style="list-style-type: none"> Do not obstruct the ventilation holes Die Belüftungöffnungen dürfen nicht verdeckt werden. Ne pas obstruer les trous d'aération. De ventilatieopeningen mogen niet worden beblokeerd 	 <p>*For sets with ventilation holes*</p> <ul style="list-style-type: none"> Do not obstruct the ventilation holes Die Belüftungöffnungen dürfen nicht verdeckt werden. Ne pas obstruer les trous d'aération. De ventilatieopeningen mogen niet worden beblokeerd 	 <ul style="list-style-type: none"> Never disassemble or modify the set in any way Versuchen Sie niemals das Gerät auseinander zu nehmen oder auf jegliche Art zu verändern. Ne jamais démonter ou modifier l'appareil d'une manière ou d'une autre Moet dit apparaat demonteren of op andere wijze modificeren.

DECLARATION OF CONFORMITY
We declare under our sole responsibility that the product, to which this declaration relates, is in conformity with the following standards: EN60068, EN60113, EN60220, EN60268-2 and EN60268-3. Following the provisions of the Directive 73/23/EEC, 89/336/EEC and 93/68/EEC Directive.

DEKLARATION ÜBER ÜBEREINSTIMMUNG
Wir erklären unter unserer Verantwortung, daß dieses Produkt, auf das sich diese Erklärung bezieht, den folgenden Standards entspricht: EN60068, EN60113, EN60220, EN60268-2 und EN60268-3. Entsprechend den Bestimmungen der Richtlinie 73/23/EEC, 89/336/EEC und 93/68/EEC.

DECLARATION DE CONFORMITE
Nous déclarons sous notre seule responsabilité que l'appareil, auquel se réfère cette déclaration, est conforme aux standards suivants: EN60068, EN60113, EN60220, EN60268-2 et EN60268-3. D'après les dispositions de la Directive 73/23/EEC, 89/336/EEC et 93/68/EEC.

BEVRIJVENHEIDVERKLARING
Wij verklaren verantwoordelijk op onze verantwoordelijkheid dat dit product, waartoe deze verklaring betrekking heeft, in overeenstemming is met de volgende normen: EN60068, EN60113, EN60220, EN60268-2 en EN60268-3. Volgens de bepalingen van de Richtlijnen 73/23/EEC, 89/336/EEC en 93/68/EEC.

CLASS 1 LASER PRODUCT
LASER 1 LASERKLASSE
LASER 1 LASERKLASSE

ADVARETILL: LITETJÄRE LASERSTRÅLNING VID ÅRNING. NÅR ÖPPNINGSBÅRÄRÖPPNINGEN BEGYNAR FUNKTIONERAR LASEREN. UDRÅTTA UDRÅTTETILL FÖR STRÅLNING.

VAROITUS: LÄTTTILN KÄYTTÖSSÄNNÄ SUKALLA ELSÄI TÄMÄ KÄYTTÖOHJEISSA MAHUSTALLA TAMMILLA SAATTAA ALTYTTÄÄ KÄYTTÖLÄÄN TUULIHALVUUNLUOKKAN I VUUTUHALVUUNLUOKKAN SUKALLA LASERSTRÄLLE.

VAROITUS: OM APPARÄTENS ÅRNING PÅ NÅRÄT KÄYTTÄN I ÖPPNA RÖRÖPPNINGEN ÖPPNINGSBÅRÄRÖPPNINGEN BEGYNAR LASEREN. UDRÅTTA UDRÅTTETILL FÖR STRÅLNING.



"SERIAL NO. _____"
PLEASE RECORD UNIT SERIAL NUMBER ATTACHED TO THE REAR OF THE CABINET FOR FUTURE REFERENCE"

< U.S.A. & Canada Models >

IMPORTANT TO SAFETY

WARNING:
TO PREVENT FIRE OR SHOCK HAZARD, DO NOT EXPOSE THIS APPLIANCE TO RAIN OR MOISTURE.

CAUTION:

- Handle the power supply cord carefully. Do not damage or deform the power supply cord. If it is damaged or deformed, it may cause electric shock or malfunction when used. When removing from wall outlet, be sure to remove by holding the plug attachment and not by pulling the cord.
- Do not open the top cover. In order to prevent electric shock, do not open the top cover. If problems occur, contact your DENON DEALER.
- Do not place anything inside. Do not place metal objects or liquid inside the MiniDisc recorder. Electric shock or malfunction may result.

Please record and retain the model name and serial number of your set shown on the rating label.
Model No. DMD-1000 Serial No. _____

CAUTION: TO REDUCE THE RISK OF ELECTRIC SHOCK, DO NOT REMOVE COVER (OR BACK). NO USER SERVICEABLE PARTS INSIDE. REFER SERVICING TO QUALIFIED SERVICE PERSONNEL.

The lightning flash with arrowhead symbol, within an equilateral triangle, is intended to alert the user to the presence of unshielded "dangerous voltage" within the product's enclosure that may be of sufficient magnitude to constitute a risk of electric shock to persons.

The exclamation point within an equilateral triangle is intended to alert the user to the presence of important operating and maintenance (servicing) instructions in the literature accompanying the appliance.

FOR U.S.A. & CANADA MODEL ONLY

CAUTION
TO PREVENT ELECTRIC SHOCK DO NOT USE THIS POLARIZED PLUG WITH AN EXTENSION CORD, RECEPTACLE OR OTHER OUTLET UNLESS THE BLADES CAN BE FULLY INSERTED TO PREVENT BLADE EXPOSURE.

NOTE:
The MiniDisc recorder uses the semiconductor laser. To allow you to enjoy music at a stable operation, it is recommended to use this in a room of 5°C (41°F) - 35°C (95°F).

LABELS (for U.S.A. model only)

CERTIFICATION
THIS PRODUCT COMPLIES WITH DHS RULES 21 CFR SUBCHAPTER J APPLICABLE AT DATE OF MANUFACTURE.

CAUTION:
USE OF CONTROLS OR ADJUSTMENTS OR PERFORMANCE OF PROCEDURES OTHER THAN THOSE SPECIFIED HEREIN MAY RESULT IN HAZARDOUS RADIATION EXPOSURE.

THE COMPACT DISC PLAYER SHOULD NOT BE ADJUSTED OR REPAIRED BY ANYONE EXCEPT PROPERLY QUALIFIED SERVICE PERSONNEL.

This device complies with Part 15 of the FCC Rules. Operation is subject to the following two conditions:
(1) This device may not cause harmful interference, and
(2) This device must accept any interference received, including interference that may cause undesired operation.

The Class B digital apparatus meets all requirements of the Canadian Interference-Causing Equipment Regulations.
Cet appareil numérique de la classe B respecte toutes les exigences du Règlement sur le matériel brouilleur du Canada.

ATTENTION

POUR PREVENIR LES CHOCS ELECTRIQUES NE PAS UTILISER CETTE FICHE POLARISEE AVEC UN PROLONGATEUR UNE PRISE DE COURANT OU UNE AUTRE SORTIE DE COURANT, SAUF SI LES LAMES PEUVENT ETRE INSEREES A FOND SANS EN LAISSER AUCUNE PARTIE A DECOUVERT.

SAFETY INSTRUCTIONS

- Read Instructions - All the safety and operating instructions should be read before the appliance is operated.
- Razan Instructions - The safety and operating instructions should be retained for future reference.
- Head Warnings - All warnings on the appliance and in the operating instructions should be adhered to.
- Follow Instructions - All operating and use instructions should be followed.
- Water and Moisture - The appliance should not be used near water - for example, near a bath tub, wash-basin, kitchen sink, laundry tub, in a wet basement, or near a swimming pool, and the like.
- Carts and Stands - The appliance should be used only with a cart or stand that is recommended by the manufacturer.
- An appliance and cart combination should be moved with care. Quick stops, excessive force, and uneven surfaces may cause the appliance and cart combination to overturn.
- Wall or Ceiling Mounting - The appliance should be mounted to a wall or ceiling only as recommended by the manufacturer.
- Ventilation - The appliance should be situated so that its location or position does not interfere with its proper ventilation. For example, the appliance should not be situated on a bed, sofa, rug, or similar surface that may block the ventilation openings, or placed in a built-in installation, such as a bookcase or cabinet that may impede the flow of air through the ventilation openings.
- Heat - The appliance should be situated away from heat sources such as radiators, heat registers, stoves, or other appliances including ampheaters that produce heat.
- Power Sources - The appliance should be connected to a power supply only in the way described in the operating instructions or as marked on the appliance.
- Grounding or Polarization - Precautions should be taken so that the grounding or polarization means of an appliance is not defeated.
- Power-Cord Protection - Power-supply cords should be routed so that they are not likely to be walked on or crushed by items placed upon or against them, paying particular attention to cords at plugs, convenience receptacles, and the point where they exit from the appliance.
- Cleaning - The appliance should be cleaned only as recommended by the manufacturer.
- Power Lines - An outdoor antenna should be located away from power lines.
- Outdoor Antenna Grounding - If an outside antenna is connected to the receiver, be sure the antenna system is grounded so as to provide some protection against voltage surge and built-up static charges. Article 810 of the National Electrical Code, ANSI/NFPA 70, provides information with regard to proper grounding of the mast and supporting structure, grounding of the lead-in wire to an antenna-discharge unit, size of grounding conductors, location of antenna-discharge unit, connection to grounding electrodes, and requirements for the grounding electrode. See Figure A.
- Nonuse Periods - The power cord of the appliance should be unplugged from the outlet when left unused for a long period of time.
- Object and Liquid Entry - Care should be taken so that objects do not fall and liquids are not spilled into the enclosure through openings.
- Damage Requiring Service - The appliance should be serviced by qualified service personnel when:
 - The power-supply cord or the plug has been damaged or
 - Objects have fallen, or liquid has been spilled into the appliance, or
 - The appliance has been exposed to rain, or
 - The appliance does not appear to operate normally or exhibits a marked change in performance, or
 - The appliance has been dropped, or the enclosure damaged.
- Servicing - The user should not attempt to service the appliance beyond that described in the operating instructions. All other servicing should be referred to qualified service personnel.

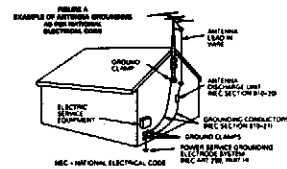

**FRONT PANEL
PANNEAU AVANT
TABLERO FRONTAL**

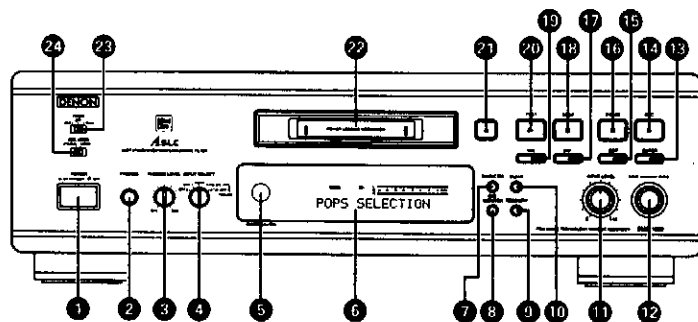

**REAR PANEL
PANNEAU ARRIERE
PANEL TRASERO**

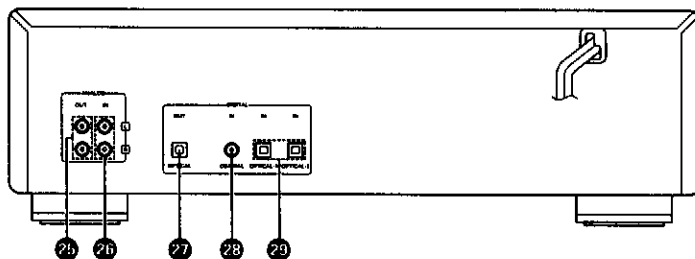

3

IMPORTANT TO SAFETY

WARNING:
TO PREVENT FIRE OR SHOCK HAZARD, DO NOT EXPOSE
THIS APPLIANCE TO RAIN OR MOISTURE.

CAUTION:

1. Handle the power supply cord carefully
Do not damage or deform the power supply cord. If it is damaged or deformed, it may cause electric shock or malfunction when used. When removing from wall outlet, be sure to remove by holding the plug attachment and not by pulling the cord.

2. Do not open the top cover
In order to prevent electric shock, do not open the top cover. If problems occur, contact your DENON DEALER.

3. Do not place anything inside
Do not place metal objects or spill liquid inside the MiniDisc recorder. Electric shock or malfunction may result.

Please, record and retain the Model name and serial number of your set shown on the rating label.

Model No. DMD-1000 Serial No. _____

NOTE:

This MiniDisc recorder uses the semiconductor laser. To allow you to enjoy music as a stable operation, it is recommended to use this in a room of 10°C (50°F) - 35°C (95°F)

Place of installation

To ensure sufficient ventilation, leave a space of at least 10 cm between the front, sides and back of the unit and walls or other objects which may obstruct ventilation.

CAUTION:

USE OF CONTROLS OR ADJUSTMENTS OR PERFORMANCE OF PROCEDURES OTHER THAN THOSE SPECIFIED HEREIN MAY RESULT IN HAZARDOUS RADIATION EXPOSURE.

THE MINIDISC RECORDER SHOULD NOT BE ADJUSTED OR REPAIRED BY ANYONE EXCEPT PROPERLY QUALIFIED SERVICE PERSONNEL.

Thank you for purchasing this DENON MiniDisc recorder. Please read the operating instructions thoroughly in order to acquaint yourself with the MiniDisc recorder and achieve maximum satisfaction from it.

Please check to make sure the following items are included with the main unit in the cartons:

- (1) Operating Instructions 1
- (2) Connection Cord 2
- (3) Optical Fiber Cord 1
- (4) Remote Control Unit (RC-270) 1
- (5) RSP (AA) Dry Cell Battery 2
- (6) Service Station List 1

— TABLE OF CONTENTS —

1	Features	5
2	Cautions on Handling	5
3	About MiniDiscs	5, 6
4	Connections	6
5	Part Names and Functions	7, 8
6	Remote Control Unit	8, 9
7	Normal Playback	9
8	Various Playback Functions	10 - 13
1	Playing a certain track	10
2	Finding the desired position while listening to the sound	10
3	Finding the beginnings of tracks during playback	10
4	Stopping playback temporarily	10
5	Playing tracks in a certain order	11
6	Playing in random order	11
7	Playing repeatedly	12, 13
9	Recording	13, 14
10	Various Recording Functions	15, 16
1	Adding track numbers during recording	15
2	Stopping recording temporarily	15
3	Recording simultaneously while playing on another component	15, 16
4	Recording from a point 8 seconds back	16
5	Recording in manual	16
11	Timer Playback and Recording	17, 18
12	Editing	19 ~ 24
13	Using the external input monitor	25
14	Messages	25
15	System Limitations	26
16	Troubleshooting	26
17	Main Specifications	26

1 FEATURES

The DMD-1000 is an audio device using the MiniDisc format. Recording is possible for up to 74 minutes at stereo recording. Operation is the same as with regular compact discs (CDs).

1. Clear sound quality

Digital recording provides clear playback sound. Also, a "JBL" (ADVANCED Super Linear Converter) is used for playback, increasing musical expression superbly when the volume is low.

2. Abundant playback functions

Programmed playback, random playback, all track repeat, single track repeat, A - B repeat etc.

3. Numerous editing functions

Editing functions for dividing, combining and moving tracks make it possible to freely manipulate recorded discs, and disc and track titles can be added. These functions make it easy to create original discs.

4. Sampling rate converter

Sources with different sampling frequencies, such as DATs and satellite broadcasts (32 kHz and 48 kHz), can be recorded digitally.

5. Timer recording and playback

A timer (not included) can be used for timer recording and playback.

2 CAUTIONS ON HANDLING

Installation
Do not place a TV set (even a small one) or other object on top of the DMD-1000.

When receiving FM, AM and TV broadcasts
If the DMD-1000's power is turned on while receiving FM, AM or TV broadcasts, there may be noise in the sound or stripes on the TV picture. Keep the DMD-1000's power turned off when not using it.

The DMD-1000 uses digital technology. If an FM tuner is placed nearby, it may cause adverse effects, such as noise in the tuner's antenna cable, etc. Be sure to use coaxial cables to connect the antenna and the tuner's antenna terminal.

When not using the DMD-1000

Under normal circumstances
Always remove the disc and turn the power off.
When leaving home for long periods of time such as for trips, be sure to unplug the power cord.

When moving the DMD-1000

Do not subject the DMD-1000 to shocks.
Always check that the disc has been removed and the connection cords disconnected before moving the DMD-1000.



3 ABOUT MINIDISCS

MiniDiscs allow a maximum of 74 minutes at stereo mode of recording and playback in a compact size.

There are two types of MiniDiscs: those for playback only, and those for recording and playback.

Only MiniDiscs with the mark shown at the right can be played and recorded on the set.



Playback only MiniDiscs

These discs are for playback only. Commercially available music MDs are of this type. These are laser discs, like regular compact discs.

Tracks on such discs cannot be added.



Recordable MiniDiscs

These are magneto-optical discs on which both recording and playback are possible. Recording is performed through magnetic modulation.

Re-recording is also possible.



Accidental erasure prevention tabs

These tabs protect recordable MiniDiscs from accidental erasure.

To avoid accidentally erasing the recording, open the tabs so that the hole is exposed. (See the diagram below.) When this is done, "Protected" is displayed if you attempt to record, erase or otherwise edit the disc, and the recording is protected. To record or erase the disc, set the tabs back to its original position (with the hole covered).



Recording on discs

MiniDiscs include a section in which the audio signals are recorded and a section in which such data as track numbers and track titles are recorded.



The TOC

With MiniDiscs, after the audio signals are recorded, data used for checking the tracks (TOC - Table of Contents) is also recorded on the disc. This TOC data is used when playing the disc. In addition, editing is performed by rewriting the TOC data. The TOC is written on the disc when the select button is pressed to eject the disc and when the power button on the remote control unit is pressed to set the power to the standby mode. When TOC writing starts, the "TOC" indicator flashes. Do not shake the main unit, press the main unit's power button or unplug the power cord while the TOC is being written. If the data is not recorded properly, it will not be possible to play the disc.

Handling MiniDiscs

- MiniDiscs are housed in cartridges, so there is no need to worry about dirt and scratches. However, dirty or warped cartridges may cause malfunction. Be careful of the following to ensure long-lasting, high quality sound:
 - Do not touch the disc surface directly.
 - Do not open the shutter by hand.
 - Do not place MiniDisces directly on dirty or humid places.
 - Do not place MiniDiscs in places exposed to direct sunlight or high temperatures.
- When sticking labels on cartridges, be careful of the things described below. Applying labels incorrectly may cause the MiniDisc to get stuck inside the set.



- Apply the label properly within the specified area. (Do not apply labels outside the specified area.)
- Do not stick one label on top of another.
- If a label is peeling off or loose, replace it with a new label.

Cleaning
Use a dry cloth to gently wipe dirt or dust off the cartridge. Do not apply excessive force.

Track numbers

Track numbers are assigned automatically when tracks or audio signals are recorded on MiniDiscs. When a new track or audio signal is added, it is assigned the next track number.

When recording a CD or MiniDisc using the digital input, the same track numbers are automatically assigned at the same places as those on the CD or MiniDisc.



Digital Capabilities

MiniDiscs recorded from a CD, etc., using the digital input cannot be digitally recorded (copied) onto another MiniDisc or DAT. This is determined by SCMS (Serial Copy Management System) regulations.

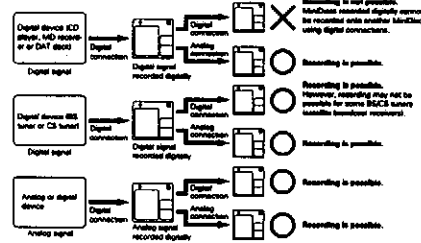

- When recording from a CD onto a MiniDisc, the track numbers on the recorded MiniDisc may not match the track numbers on the CD.
- The function does not work with such digital equipment as BS/CS tuners or DAT decks, in which case the track numbers are assigned using the auto track increment function, in the same way as for recordings using the analog input.
- When recording from a BS/CS tuner or DAT deck using digital connectors:
 - Track numbers may not be recorded properly if there is much noise in the blank sections between tracks.
 - Track numbers may be recorded at points in the middle of a track where the signal level is extremely low. If this should happen, use the editing function after recording is completed.
- When recording a DAT or satellite broadcast, the track number will change if the DAT or satellite broadcast mode (sampling frequency changes). In some rare cases, noise may also be recorded. If this should happen, use the editing function after recording is completed. (See Page 18)



- Track numbers may not be assigned properly for some recordings, for example when there is noise in the signals.
- In some cases the auto track increment function will not be used and the entire recording will only have one track number. (See Page 13.)

4 CONNECTIONS

1. Connecting the analog input and output jacks (analog connections)

- Use the included connection cords (pin-plug cords) to connect the analog input and output jacks.
 - Connect the left (L) and right (R) analog output (ANALOG OUT) jacks on the DMD-1000 to the left (L) and right (R) tape input (tape playback) jacks on the amplifier.
 - Connect the left (L) and right (R) analog input (ANALOG IN) jacks on the DMD-1000 to the left (L) and right (R) tape output (tape recording) jacks on the amplifier.

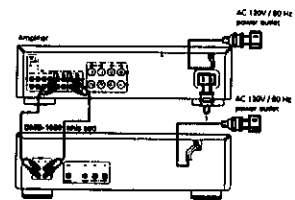

2. Connecting the digital input and output jacks (digital connections)

Use the included optical fiber cord to connect the OPTICAL digital input and output jacks. Use separately sold 75 Ω/ohms pin-plug cords to connect the COAXIAL digital input and output jacks.

- Connect the digital output (DIGITAL OPTICAL OUT) jack on the DMD-1000 to the digital optical input of a digital processor or D/A unit.
- Connect the digital input (DIGITAL OPTICAL IN or DIGITAL COAXIAL IN) jacks on the DMD-1000 to the digital output (DIGITAL OPTICAL OUT or DIGITAL COAXIAL OUT) jacks on a CD player, digital processor or D/A unit.

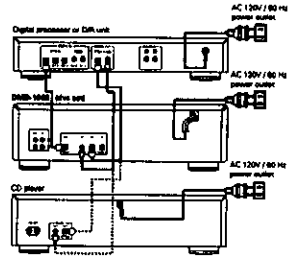

This model comes with one optical fiber cable. Please contact your nearest Denon customer service center or office if you want to use a separately sold optical fiber cord.

- NOTES:**
- Do not plug in the power cord until all other connections have been made.
 - Check the channels and be sure to connect left to left (L—white), right to right (R—red).
 - Insert the plugs securely. Incomplete connections may result in noise.

- After unplugging the power cord, wait about 5 seconds before plugging it back in.
- Note that clamping the connection cords (pin-plug cords) together with the power cord may result in humming or noise.

5 PART NAMES AND FUNCTIONS

1 POWER button

- The power turns on when the button is switched from the off position (OFF) to the on position (ON).
- The power turns off when the button is switched from the on position (ON) to the off position (OFF).
- When the button is in the on position (ON), the power button on the remote control unit can be used to switch the power between the on and standby modes. "OFF" is displayed when the power is in the standby mode.
- If a disc is inserted while in the standby mode, the power turns on automatically and the disc is drawn in. If a disc is inserted, the power turns on automatically when the play or eject button is pressed, and that operation is performed.

NOTES:

- The model is equipped with a backup function for storing the recorded or edited TOC (Table of Contents) data even when the power button is set to the off position (OFF) or the power cord is unplugged.
- Before using the backup function, press the power button and leave the power on for about 15 minutes.
- The data is backed up for 2 or 3 days. Write the TOC data on the disc immediately after recording or editing.
- If the backup data is lost, the recorded or edited data is erased and cannot be retrieved. (See Page 5.)

2 Headphones jack (PHONES)

- Use the jack to listen with headphones. (Headphones are not included.)

3 Headphones volume control (PHONES LEVEL)

- Use this to adjust the output level (volume) of the headphones jack (PHONES).

4 Input select switch (INPUT SELECT)

- Use this to select the input source for recording.
- The input source cannot be switched during recording. To do so, first set the recording standby or stop mode.

5 REMOTE SENSOR

- Point the remote control unit (RC-270) towards the sensor when operating it.

6 Display

7 CHARACTER button

- Use this button when inputting tries to switch between capital letters, small letters and special letters.

8 External input monitor button (EXT. MONITOR)

- When this button is pressed, the input signal selected with the input select switch can be monitored on the set's output jacks.

9 RECOVERY button

- When recording or editing has been performed repeatedly, the recordable time may be shorter than the MiniDisc's maximum recording time. If this happens, press this button to reorganize the contents data (TOC) and increase the recordable time.
- The recordable time may not increase for some MiniDiscs.

10 CLEAR button

- Press this to clear programmed tracks or title characters.

11 Input level adjustment control (INPUT LEVEL)

- Use this to adjust the analog input signal recording level.
- This control does not affect digital recording.

12 Jog dial

- Use this dial to find the beginning of tracks and for editing.
- Use this dial to input letters when giving titles to tracks on the disc.

13 ENTER button

- Press this to enter the edited data.

14 Record button (REC)

- Press this button to record.
- The recording standby mode is set when the REC button is pressed alone.
- Press the play button (PLAY) while in the recording standby mode to start recording.
- To stop recording or to cancel the recording standby mode, press the stop button (STOP).

15 EDIT button

- This button is used when erasing disc and track titles and for such editing operations as erasing, dividing, combining and moving tracks. (See Page 18—24.)

16 Pause button (PAUSE)

- Press this button to stop playback or recording temporarily.
- Press the play button (PLAY) to cancel the pause mode.

17 Manual search forward button (FWD)

- Press this to search forward rapidly. (See Page 10.)

18 Stop button (STOP)

- Press this button to stop playback or recording.
- Press this button to clear the editing operation.

19 Manual search reverse button (REV)

- Press this to search backward rapidly. (See Page 10.)

20 Play button (PLAY)

- Press this button to start playback or recording.
- Press the button during recording to add a track number.

21 Eject button (EJECT)

- Press this to eject the disc.

22 Disc insertion slot

- When a disc is inserted here, it is automatically drawn into the set.
- Be sure to insert the disc in the proper direction.

★ Note on ejecting discs

- After pressing the eject button do not push the disc back in while it is being ejected. To reinsert the disc, wait until it comes fully out and stop, then press it back in.

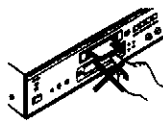

23 Timer select switch (TIMER)

- Use this for timer recording or playback when using the DMD-1000 with a separately sold audio timer.

24 Recording mode switch (REC MODE)

- Set the switch to "STEREO" to record in stereo, "MONO" to record in monaural.
- With monaural recording it is possible to record approximately twice as much as with stereo recording.
- The setting cannot be changed during recording. To change the setting, first switch to the pause or stop mode.

25 Analog output jacks (ANALOG OUT)

- Connect these to the amplifier's input jacks (TAPE-PR).

26 Analog input jacks (ANALOG IN)

- Connect these to the amplifier's output jacks (TAPE-REC).
- The audio signals from other components connected to the amplifier can be recorded on this set.
- To do so, set the input select switch (INPUT SELECT) to the "ANALOG" position.

27 Digital output jack (DIGITAL OPTICAL OUT)

- Digital data is output from this jack in the form of optical signals.
- When this jack is connected to the digital input (OPTICAL IN) jack on a digital processor or D/A unit, the sound from the DMD-1000 can be heard over the speakers.

28 Digital input jack (DIGITAL COAXIAL IN)

- Use this jack to input digital data.
- When connected to the digital optical output jack of a CD player, DAT deck, satellite broadcast tuner or another MD recorder, the sound from that unit can be recorded digitally on the DMD-1000. To do so, set the input select switch (INPUT SELECT) to the "COAX" position.

29 Digital input jack (DIGITAL OPTICAL IN 1, 2)

- Digital data is input from this jack in the form of optical signals.
- When connected to the digital optical output jack of a CD player, DAT deck, satellite broadcast tuner or another MD recorder, the sound from that unit can be recorded digitally on the DMD-1000. Two sets of digital inputs can be connected, so set the input select switch to "OPT-1" or "OPT-2".

* It is not possible to record the digital data of sources for which digital copying is prohibited. ("Copy Prohibit" is displayed.)

6 Display

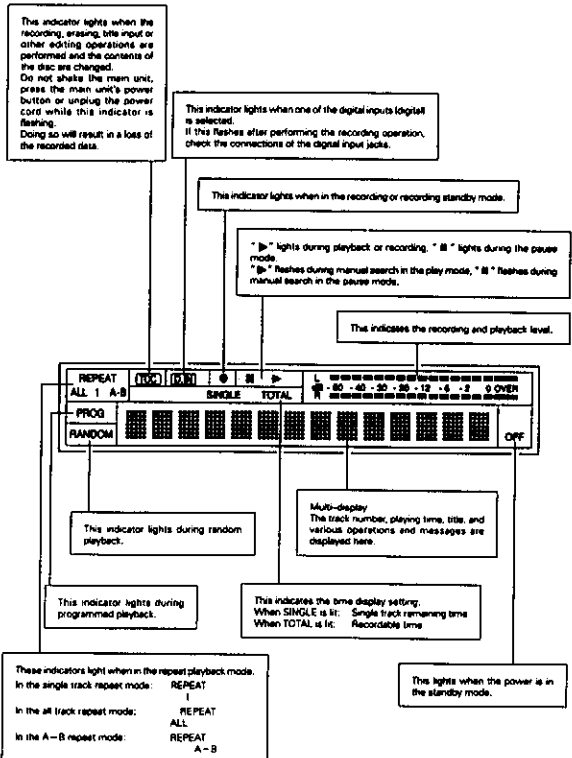

8 REMOTE CONTROL UNIT

* The included remote control unit (RC-270) can be used to operate the DMD-1000 from a distance.

Inserting the batteries

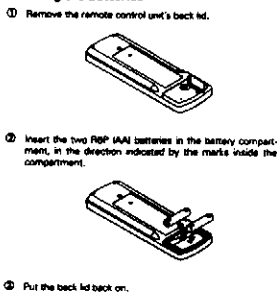

Caution on batteries

- Use RPP (AA) batteries in the remote control unit.
- The batteries should be replaced with new ones after approximately one year, though this depends on the frequency with which the remote control unit is used.
- Even if the batteries are less than a year old, replace them with new ones if the remote control unit no longer operates even from a short distance from the main unit.
- When inserting new batteries, wait about two minutes after removing the old batteries before inserting the new ones.
- Be sure to set the batteries in the proper "+" and "-" directions, as indicated by the marks in the remote control unit's battery compartment.
- Remove the batteries when not using the remote control unit for long periods of time.
- To avoid explosions and fluid leakage:
 - Do not take one new battery with one old one.
 - Do not use two different types of batteries.
 - Do not short-circuit, disassemble, heat or dispose of batteries in flames.
- If the battery fluid should leak, wipe all the fluid off the battery compartment, then insert new batteries.

Using the remote control unit

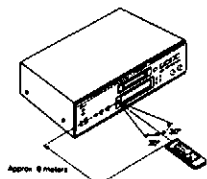

- When operating the remote control unit, point it at the main unit as shown in the diagram.
- The remote control unit can be operated from a direct distance of approximately 8 meters from the main unit. This distance will be shortened, however, if there are obstacles or when operated from an angle. (The remote control unit will operate from a horizontal angle of up to about 30°.)

NOTE:

- The remote control unit may not operate if the remote sensor is exposed to direct sunlight or strong artificial light, or if there is an obstacle between it and the remote sensor.
- Do not press buttons on the main unit and on the remote control unit at the same time. Doing so will result in malfunction.

8

Names and Functions of Remote Control Unit Buttons

* Buttons not explained here function in the same way as the corresponding buttons on the main unit.

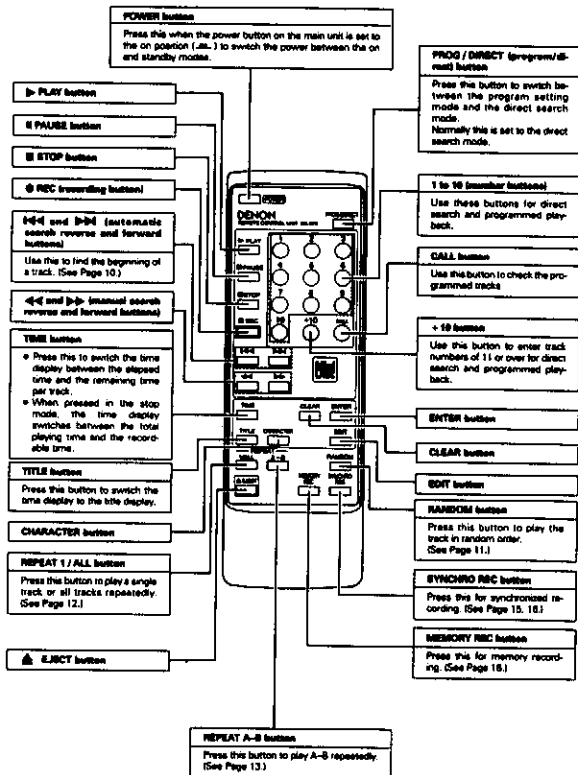

7 NORMAL PLAYBACK

1. Starting playback

First try playing the tracks in order.

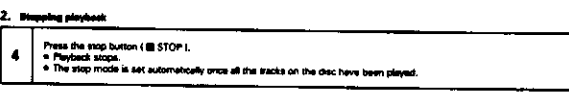
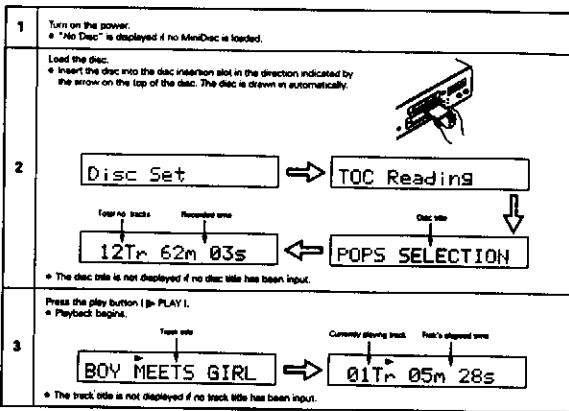
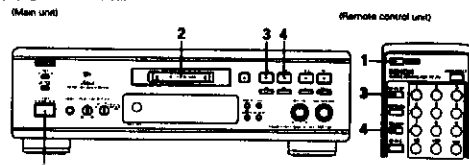

8 VARIOUS PLAYBACK FUNCTIONS

In addition to normal playback, the DMD-1000 also offers the playback functions described below.

1. Playing a certain track (remote control unit only) Direct Search

(Remote control unit)

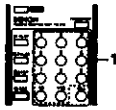

- Use the number buttons (1) to (10) and the +10 button to input the number of the desired track.
 - For example: Press button (1) to listen to the 4th track, buttons (1) and (1) to listen to the 12th track, (1) and (10) and (1) to listen to the 30th track. Playback begins from that track.

2. Finding the desired position while listening to the sound Manual Search

Use this function to skip rapidly through the disc while listening to the sound. This function comes in handy when you want to find a certain section within a long track.

(Main unit)

(Remote control unit)



(1) Searching forward

- During playback, press and hold in the manual search forward button (▶▶).
 - Normal playback resumes from the point at which the button is released.
 - Playback stops if the end of the last track on the disc is reached while pressing the manual search forward button (▶▶).
 - For high-speed forward search without hearing the sound, press the manual search forward button while in the pause mode.

(2) Searching backward

- During playback, press and hold in the manual search reverse button (◀◀).
 - Normal playback resumes from the point at which the button is released.
 - Manual search stops and playback starts if the beginning of the first track on the disc is reached while pressing the manual search reverse button (◀◀).
 - For high-speed backward search without hearing the sound, press the manual search reverse button while in the pause mode.

NOTE:
 • There may be a slight break in the sound when returning to normal playback from the manual search mode.

10

5. Playing tracks in a certain order Programmed Playback

(Remote control unit)

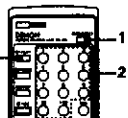

- Use this function to select certain tracks from the disc and program them to play in a certain order.
- Up to 25 tracks can be programmed.

- In the stop mode, press the PROG/DIRECT button.
 - The "PROG" indicator lights.
- Use the number buttons and the +10 button to select the tracks for programmed playback.
 - For example, to program the 3rd, 12th and 7th tracks, press PROG/DIRECT, (3), (12) and (7).
- Press the play button (▶ PLAY).
 - The tracks are played in the programmed order.

- To check the contents of the program, press the CALL button. The programmed tracks appear in the programmed order on the display each time the CALL button is pressed.
- To change the program, press the CLEAR button while in the stop mode, then program the desired track. The last programmed track is replaced with the newly input track.
- To clear the entire program, press the PROG/DIRECT or EJECT (▲) button while in the stop mode.

NOTES:
 • The single track repeat mode and A-B repeat mode cannot be set during random playback.
 • Programs with total playing times of over 256 minutes can be set, but the time will not be displayed properly.

3. Finding the beginnings of tracks during playback Automatic Search

(1) Moving ahead to the beginning of the next track

(Main unit)

(Remote control unit)



- Either turn the jog dial on the main unit clockwise (▶) or press the [▶▶] automatic search forward button on the remote control unit.
 - During the search operation, turn the jog dial on the main unit counterclockwise (◀) again or press the [▶▶] automatic search forward button on the remote control unit again to move further on to the beginning of the following track.

(2) Moving back to the beginning of the current track

(Main unit)

(Remote control unit)



- Either turn the jog dial on the main unit counterclockwise (◀) or press the [◀◀] automatic search reverse button on the remote control unit.
 - During the search operation, turn the jog dial on the main unit counterclockwise (◀) again or press the [◀◀] automatic search reverse button on the remote control unit again to move further back to the beginning of previous track.

4. Stopping playback temporarily Pause

Use this function to stop playback temporarily then resume from the same point.

(Main unit)

(Remote control unit)



- During playback, press the pause button (⏸ PAUSE).
 - The pause mode is set.
 - Press the play button to resume playback from the point at which the pause mode was set.

6. Playing in random order Random Playback

Use this function to play all the tracks on the disc once in random order.

(Main unit)

(Remote control unit)

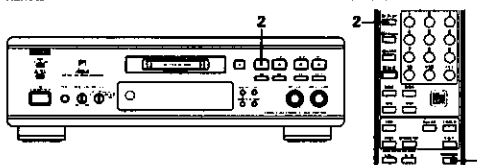

- In the stop mode, press the RANDOM button.
 - The "RANDOM" indicator lights.
- Press the play button (▶ PLAY).
 - Tracks are automatically played in random order.
 - During the all-track repeat mode: All the tracks are played once in random order, then repeated in another random order.
 - To cancel the random play mode, either set the stop mode or press the RANDOM button again.

NOTE:
 • The single track repeat mode and A-B repeat mode cannot be set during random playback.

7. Playing repeatedly

Repeat Playback

(1) Playing a single track repeatedly (Single Track Repeat)

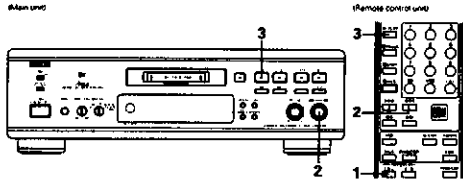

1	<p>Press the REPEAT 1/ALL button once.</p> <ul style="list-style-type: none"> The "REPEAT" indicators light on the display and the single track repeat mode is set.
2	<p>Either turn the jog dial on the main unit or use the automatic search buttons (⏮ and ⏭) on the remote control unit to select the track to be played repeatedly.</p>
3	<p>Press the play button (▶ PLAY).</p> <ul style="list-style-type: none"> Playback starts. Once the selected track ends, it is played again from the beginning. The single track repeat mode can also be set by pressing the REPEAT 1/ALL button during playback. The current track is played repeatedly. To cancel the single track repeat mode, press the REPEAT 1/ALL button repeatedly until the "REPEAT" indicator turns off.

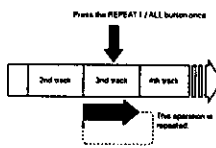

(2) Playing all tracks repeatedly (All Track Repeat)

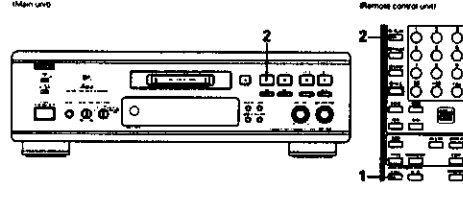

1	<p>Press the REPEAT 1/ALL button twice.</p> <ul style="list-style-type: none"> The "REPEAT ALL" indicators light on the display and the all track repeat mode is set.
2	<p>Press the play button (▶ PLAY).</p> <ul style="list-style-type: none"> The disc is played repeatedly. The all track repeat mode can also be set by pressing the REPEAT 1/ALL button during playback. If the REPEAT 1/ALL button is pressed during programmed playback, the tracks are played repeatedly in the programmed order. To cancel the all track repeat mode, press the REPEAT 1/ALL button repeatedly until the "REPEAT" indicator turns off.

NOTE:

- The single track repeat mode and A-B repeat mode cannot be set during programmed playback or random playback.

(3) Playing a section between any two points repeatedly (A-B Repeat)

This function allows you to play a certain section within a track repeatedly.

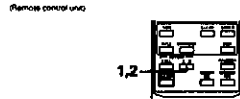

1	<p>During playback, press the A-B repeat button at the position at which you want to start repeating (point A).</p> <ul style="list-style-type: none"> The "REPEAT A-B" indicator lights.
2	<p>Press the A-B repeat button again at the position at which you want to stop repeating (point B).</p> <ul style="list-style-type: none"> The "REPEAT A-B" indicator lights, the pickup returns to point A, and the section is played repeatedly.

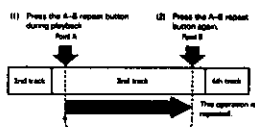

- To stop A-B repeat playback, press the REPEAT A-B button on the remote control unit until the "REPEAT" indicator turns off. The A-B repeat mode is cancelled and normal playback starts from the beginning of the current track.
- If the stop button (⏻ STOP) is pressed, the A-B repeat mode is cancelled and the stop mode is set.

NOTE:

- A-B repeat playback is not possible during programmed playback or random playback.
- The automatic and manual search functions cannot be used during A-B repeat playback or when setting point B.
- When A-B repeat playback is cancelled when point B is set on a different track from point A, playback resumes from the beginning of the track that is playing when the A-B repeat mode is cancelled.

8 RECORDING

- When recording on an already recorded disc, recording automatically starts from the end of the section last recorded. When doing so, pay attention to the remaining time.
- To clear the entire content of the disc and record from the beginning, first erase the entire disc. (For instructions on erasing the entire disc, refer to "Editing — (1) Erasing all tracks" on Page 13.)
- To record on a disc, make sure the accidental erasure prevention tab is closed and the hole is covered.

1. Starting recording

- The recording pause mode is set automatically if a blank disc or no-track disc is loaded. (Auto Rec Pause function)

(1) Analog recording

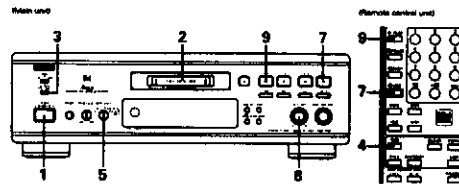

1	Turn on the power.
2	Load the recordable MiniDisc on which you want to record.
3	Set the recording mode switch to the mode in which you want to record.
4	<p>When using an already recorded MiniDisc, press the TIME button to check the recordable time.</p> <ul style="list-style-type: none"> The time display switches between the total recorded time and the recordable time each time the TIME button is pressed.
5	<p>Set the input select switch (INPUT SELECT) to the "ANALOG" position.</p> <ul style="list-style-type: none"> "Analog ATM On" or "Analog ATM Off" appears on the multi-display. When the analog A.T.M. (Auto Track Marking) function is on (when "Analog ATM On" is displayed), track numbers are automatically added when soundless sections (about 1.5 sec) are detected in the recording input signal. When the analog A.T.M. function is off (when "Analog ATM Off" is displayed), track numbers are not automatically added. (For instructions on adding track numbers, refer to "Editing — (2) Dividing tracks" on Page 20.)
6	Start playing the selection you want to record on the CD player, cassette deck, etc.
7	<p>Press the record button (Ⓜ REC).</p> <ul style="list-style-type: none"> The recording standby mode is set.
8	<p>Use the INPUT LEVEL control to adjust the recording level.</p> <ul style="list-style-type: none"> Adjust the INPUT LEVEL control so that the "OVER" indicator does not light even when the volume is loudest. After adjusting, set the source to be recorded to the standby mode.
9	<p>Press the play button (▶ PLAY).</p> <ul style="list-style-type: none"> Recording starts.
10	Start playing the selection you want to record on the CD player, cassette deck, etc.

2. Digital recording

- The set includes a sampling converter.
- When recording DATs or satellite broadcasts (32 kHz or 48 kHz) whose digital input signal sampling frequency is different from that of MiniDiscs (44.1 kHz), the sampling frequency is automatically converted to 44.1 kHz.

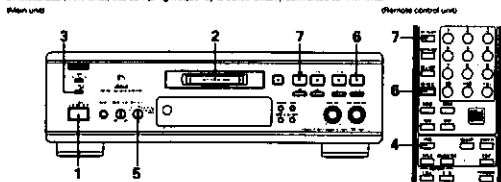

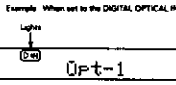
1	Turn on the power.
2	Load the recordable MiniDisc on which you want to record.
3	Set the recording mode switch to the mode in which you want to record.
4	When using an already recorded MiniDisc, press the TIME button to check the recordable time. • The time display switches between the total recorded time and the recordable time each time the TIME button is pressed.
5	Set the input select switch (INPUT SELECT) to the "COAX", "OPT-1" or "OPT-2" position. • "Coax", "Opt-1" or "Opt-2" appears on the multi-display. • If the "LOCK" indicator is flashing, check the connections to the digital input jacks. Example: When set to the DIGITAL OPTICAL IN 1 Lights 
6	Press the record button (RECL). • The recording standby mode is set. • If the input select switch is switched while in the recording pause mode, the digital input signal's sampling frequency is displayed for approximately 2 seconds.
7	Press the play button (PLAY). • Recording starts.
8	Play the selection to be recorded on the CD player, etc.

NOTE:
 • If the recording mode switch is switched to "MONO" while stereo audio signals are being input, the level meter display and monitor signals do not switch to monoaural.

2. Stopping recording

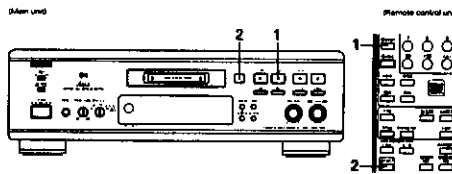

1	During recording, press the stop button (STOP). • The stop mode is set automatically once the end of the recordable time is reached.
2	Press the EJECT button (▲). • The TOC data is written and the disc is ejected. • When TOC writing starts, the "LOCK" indicator flashes. Do not shake the main unit, press the main unit's POWER button or unplug the power cord while the TOC is being written. If the data is not recorded properly, it will not be possible to play the disc. • The TOC data can also be written by setting the power to the standby mode by pressing the power button on the remote control unit.

NOTES:
 • When performing digital recording, there is no need to adjust the recording level. The position of the INPUT LEVEL control does not affect the recording level.
 • When performing digital recording of CDs or MiniDiscs, the track numbers are recorded automatically. (Depending on the recorded content on the CD or MiniDisc and on the type of CD player, the track numbers may differ from those on the original CD or MiniDisc.) (See Page 6.)
 • When recording on CDs or MiniDiscs, track numbers may be incremented by 1. If this happens, erase the unnecessary track numbers. (See Page 18.)
 • When recording digital sources other than CDs or MiniDiscs, track numbers are automatically added when blank sections are detected. (See Page 6.)
 • During digital recording from CDs or MiniDiscs, the track number may not change if the same track is programmed twice in a row or if the single track repeat mode is set.
 • It is not possible to make digital recordings of MiniDiscs which have already been recorded digitally. The DMD-1000 includes a serial copy management system. This system limits reproduction of digital signals on digital audio devices to "one generation". Use analog recording to record MiniDiscs originally recorded digitally.
 • To eject the MiniDisc if the "Copy Prohibit" or "Digital Unlock" message is displayed during digital recording and the recording pause mode is set, first press the stop button, then press the eject button to eject the MiniDisc.

10 VARIOUS RECORDING FUNCTIONS

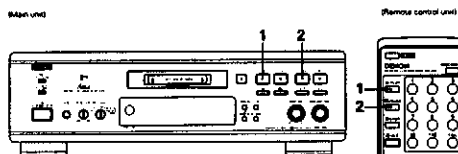

1. Adding track numbers during recording

- Track numbers can be added during recording regardless of the recording mode.

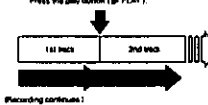
1	During recording, press the play button (PLAY). • When the play button (PLAY) is pressed during recording, a track number is added at that point. • A new track number cannot be added for approximately 4 seconds after the last track number for stereo recordings, approximately 8 seconds after the last track number for monoaural recordings. Recording continues: 
---	--

2. Stopping recording temporarily

- Recording can be stopped temporarily then resumed from the same point.

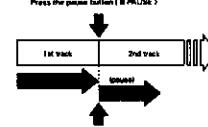
2	During recording, press the pause button (PAUSE). • When the pause button (PAUSE) is pressed during recording, the pause mode is set at that point and the track number changes. • Press the play button (PLAY) to resume recording. Recording continues: 
---	---

NOTE:
 • The TOC is written on the disc when the eject button is pressed to eject the disc and when the power button on the remote control unit is pressed to set the power to the standby mode.
 • After recording, press the EJECT button (▲) to record the TOC data before performing other operations.
 • The "LOCK" indicator flashes while the TOC data is being recorded. Do not shake the main unit, press the main unit's POWER button or unplug the power cord while the TOC is being written. If the data is not recorded properly, it will not be possible to play the disc.

3. Recording simultaneously while playing on another component

Synchronized Recording

- With this function you can start recording automatically when playback starts on a component connected to the input jacks.

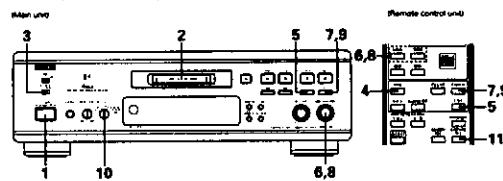

1	Turn on the power.
2	Load the recordable MiniDisc on which you want to record.
3	Switch the recording mode switch to the mode in which you want to record.
4	When using an already recorded MiniDisc, press the TIME button to check the recordable time. • The time display switches between the total recorded time and the recordable time each time the TIME button is pressed.
5	In the stop mode, press the EDIT button. • "Edit Mode" is displayed.
6	Either turn the jog dial on the main unit or press one of the automatic search buttons (◀ and ▶) on the remote control unit. • Display "Sync Rec Lev.?"
7	Press the ENTER button. • "Sync Lev. -54 dB" is displayed. • The default value is -54 dB. • (A synchronized recording level of -54dB means that recording starts automatically on the MiniDisc when playback signals of -54 dB or greater are detected after a blank section of 4 seconds or more in the playback signals input from an external component.)
8	Turn the jog dial on the main unit or use the automatic search buttons (◀ and ▶) on the remote control unit to set the synchronized recording level. • The level can be adjusted in steps of 6 dB between -54 dB and -30 dB. • When the synchronized recording level is set to -30 dB, -36 dB, -42 dB or -48 dB, the signal level for the auto track increment function which automatically adds track numbers when blank sections are detected is set to the same level. When set to -54 dB, the signal level is set to approximately -50 dB.
9	Press the ENTER button. • "Complete" is displayed. • The synchronized recording level is set.
10	Set the input select switch (INPUT SELECT).
11	Press the SYNCHRO REC button. • Set the recording pause mode and "Synchro Rec" is displayed.

- 12 Play the track you want to record on the CD player, cassette deck, etc.
 • Recording starts automatically.
- When recording with the default synchronized recording level, skip steps 5 to 9.
 • To cancel the synchronized recording mode, press the STOP button.

NOTE:

- When recording an analog input, adjust the recording level before synchronized recording.
- When a blank section of 4 seconds or more is detected in the playback signal during synchronized recording, the track number increases by one and the recording pause mode is set automatically. When playback resumes recording also resumes.
- If a signal equal to or greater than the set recording level is being input when the synchronized recording button (SYNCHRO REC) is pressed, recording starts immediately.
- Synchronized recording may not work properly if there is noise in the blank sections between tracks. If this happens, change the synchronized recording level setting.
- During synchronized recording, the set operates as if the input select switch (INPUT SELECT) is set to ANALOG A.T.M. ON, even if it is set to ANALOG A.T.M. OFF.
- The track number increases if the sampling frequency switches when in the synchronized recording pause mode.
- The recording mode cannot be changed when in the synchronized recording pause mode.
- The synchronized recording level is reset to the default value when the power of the main unit is turned off (. . .).

4. Recording from a point 8 seconds back **Memory Recording**

• With this function you can start recording from a point up to 8 seconds back in the sound that was being input to the set when the recording pause mode was set.

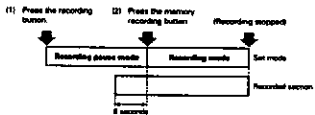

• Use this function to prevent missing the beginning of the satellite broadcast or other program you want to record using the "AIR CHECK" function.

(Remote control unit)

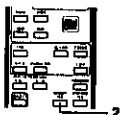

- Perform the operations under "Starting to Record" on Pages 13 and 14.
 • To record an analog input, perform steps 1 to 8 under "Recording an Analog Input".
 • To record a digital input, perform steps 1 to 6 under "Recording a Digital Input".
 - Press the MEMORY REC button on the remote control unit.
 • Recording starts from a point up to 8 seconds before the button was pressed.
 • "Memory Rec" is displayed.
- To cancel the memory rec mode, press the STOP button.

NOTE:

- The set stores in the memory the sound which is being input at the point when the recording pause mode is set. Thus, the sound from 8 seconds ago cannot be recorded if recording is started more than 8 seconds after the recording pause mode is set. In addition, if the input is switched with the input select switch (INPUT SELECT) in the 8 seconds before memory recording is started, the sound recorded before the input was switched may be recorded.

5. Recording in monaural **Monaural Recording**

• With monaural recording it is possible to record approximately twice as much as with stereo recording.
 • Use this function to record tracks originally recorded in monaural or programs consisting mostly of talk.

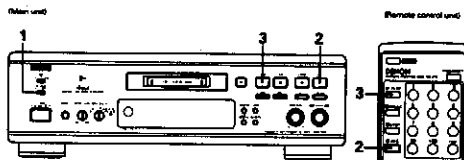

- Set the recording mode switch to "MONO".
 • "Mono" is displayed.
- Press the REC button.
 • The recording standby mode is set.
- Press the PLAY button.
 • Recording starts.

NOTE:

- The recording mode cannot be switched during recording.
- If the recording mode switch (REC MODE) is switched during the editing operation, the editing operation is cleared.
- The monitor signals and level meter display do not switch to monaural, even if the recording mode switch is switched to "MONO".

16

11 TIMER PLAYBACK AND RECORDING

• A separately sold auto timer can be used to start playback or recording at a specific time.
 • Also refer to the operating instructions for the auto timer and amplifier.

1. Connections

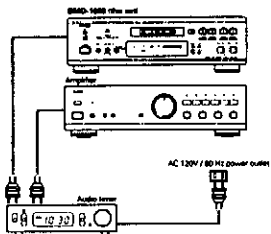

2. Timer playback

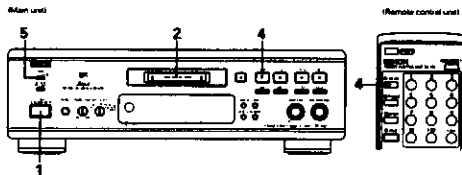

- Turn on the power of the DMD-1000 and the connected components.
- Load the MiniDisc for timer playback into the DMD-1000.
- Set the amplifier's input selector to "MD".
- Press the play button (▶ PLAY).
 • Play the disc to check the volume.
- Set the DMD-1000's timer select switch (TIMER) to "PLAY".
- Set the auto timer for the desired time.
- Press the power button on the remote control unit to set the power to the standby mode. Turn the auto timer ON.
 • When the set time is reached, the power of the various components turns on automatically and playback begins from track one.

3. Timer recording

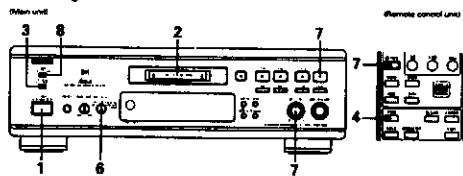

- Turn on the power of the DMD-1000 and the connected components.
- Load the recordable MiniDisc for timer recording into the DMD-1000.
- Set the recording mode switch to the mode in which you want to record.
- When using an already recorded MiniDisc, press the TIME button to check the recordable time.
- Set the input selector button on the amplifier or receiver to the source to be recorded.
- Set the input select switch (INPUT SELECT) on the DMD-1000 to the source to be input.
- Press the record button and adjust the recording level. (For analog inputs only)
 • Adjust so that the level meter does not light up to "OVER".
- Set the DMD-1000's timer select switch (TIMER) to "REC".
 • When the set time is reached, the power turns on and recording begins.
- Set the auto timer for the desired time.
- Press the power button on the remote control unit to set the power to the standby mode. Turn the auto timer ON.
 • When the set time is reached, the power of the various components turns on automatically and recording begins.

NOTES:

- Be sure to keep the main unit's power button in the on position when performing timer playback and recording. Timer playback and recording will not work if the power button is in the off position.
- The recording made using timer recording is stored on the disc the next time the power is turned on.
- During this, the [TDC] indicator flashes. Do not shake the main unit, press the main unit's power button or unplug the power cord while the "TDC" is flashing.
- To operate the DMD-1000 again after timer recording, first eject the disc, then reload it.
- The recording made using timer recording may be cleared if the DMD-1000's power is not turned on for 2 or 3 days. Be sure to turn on the DMD-1000 within 2 or 3 days.
- Be sure to set the DMD-1000's timer select switch (TIMER) to the "OFF" position when not using timer playback or recording.
- It takes several seconds from the time the timer recording start time is reached until the power is turned on and recording actually starts. Take this into consideration when setting the timer's start and stop times.
- The recordable area may be shortened by several seconds when using timer recording on discs on which editing (erasing tracks, etc.) has been performed repeatedly.
- The POWER button, TIME button and input level adjustment control (INPUT LEVEL) do not function during timer recording.
- To stop recording during timer recording, set the timer select switch (TIMER) to "OFF", then press the stop button (■ STOP).
- Timer recording is not possible when the disc's accidental erasure prevention tab is open or when the disc is already full ("Disc Full").





12 EDITING

The editing functions can be used to add track numbers, combine tracks, erase unwanted sections, etc. It is also possible to give titles to discs and tracks. Use the editing functions to get the best of the excellent versatility that MiniDiscs offer.

1. Editing

The DMD-1000 is equipped with the following four editing functions:

Editing functions

	<ul style="list-style-type: none"> • Erasing angle tracks (See Page 18.) • Erasing all tracks (See Page 18.) • Erasing A-B tracks (See Page 19.) • Erasing disc titles (See Page 23.) • Erasing track titles (See Page 23.) • Erasing all titles (See Page 23.)
	• Combining tracks (See Page 20.)
	• Dividing tracks (See Page 20.)
	<ul style="list-style-type: none"> • Moving tracks (See Page 21.) • Moving program tracks (See Page 21.)

These four editing functions can be combined for a variety of editing possibilities.
 • When editing or adding titles, close the accidental erasure prevention tab to cover the hole.

(1) Erasing tracks

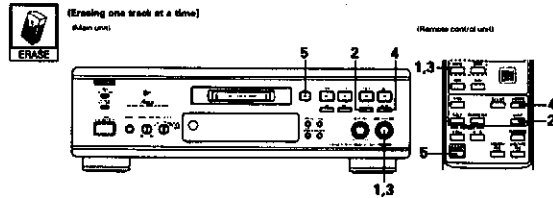

1	In the stop mode, display the number of the track to be erased. • Either turn the jog dial on the main unit or use the automatic search buttons (◀◀ and ▶▶) on the remote control unit to display the number of the track to be erased. • This step is unnecessary when you want to erase the currently playing or paused track.
2	Press the EDIT button. • "Edit Mode" is displayed.
3	Either turn the jog dial on the main unit or press one of the automatic search buttons (◀◀ and ▶▶) on the remote control unit. • Display "Track Erase?".
4	Press the ENTER button to erase the track. • "Complete" is displayed. • The stop mode is set once the operation is completed. • During the pause mode, that track is erased. • When a track is erased during the pause mode, the stop mode is set after the track is erased. • When a track is erased, the numbers of the tracks following that track are all decreased by one.
5	Press the EJECT button (▲). • The TOC data is written and the disc is ejected. • When TOC writing starts, the [TDC] indicator flashes. Do not shake the main unit, press the main unit's POWER button or unplug the power cord while the TOC is being written. If the data is not recorded properly, it will not be possible to play the disc. • The TOC data can also be written by setting the power to the standby mode by pressing the power button on the remote control unit.

• When erasing two or more tracks, start from the track with the largest number, since the numbers of the following tracks decrease when a track is erased.
 • To cancel the erasing procedure, press the STOP or CLEAR button before step 4 above to display "Track Erase?".

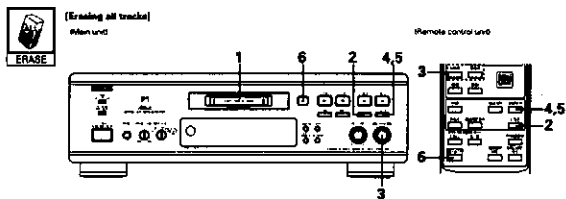

1	Load the disc you want to erase.
2	In the stop mode, press the EDIT button. • "Edit Mode" is displayed.
3	Either turn the jog dial on the main unit or press one of the automatic search buttons (◀◀ and ▶▶) on the remote control unit. • Display "ALL Erase?".
4	Press the ENTER button. • The "Erase OK?" message appears.
5	Press the ENTER button to erase the track. • "Complete" is displayed, then the "Blank Disc" message appears.
6	Press the EJECT button (▲). • The TOC data is written and the disc is ejected. • When TOC writing starts, the [TDC] indicator flashes. Do not shake the main unit, press the main unit's POWER button or unplug the power cord while the TOC is being written. If the data is not recorded properly, it will not be possible to play the disc. • The TOC data can also be written by setting the power to the standby mode by pressing the power button on the remote control unit.

• When the all erase function is used, both the tracks and the disc title are erased.
 • To cancel the erasing procedure, press the STOP or CLEAR button before step 5 above to display "ALL Erase?" or "Erase OK?".

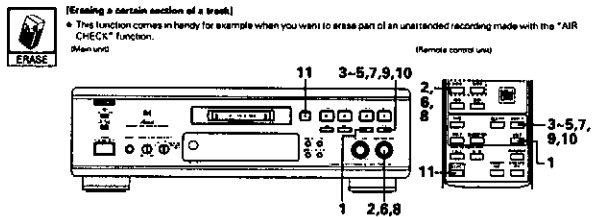

1	In the play mode or pause mode, press the EDIT button. • "Edit Mode" is displayed.
2	Either turn the jog dial on the main unit or press one of the automatic search buttons (◀◀ and ▶▶) on the remote control unit. • Display "A-B Erase?".
3	Press the ENTER button. • "A Point In?" is displayed.
4	Press the ENTER button at the position where you want to start erasing (point A). • "B Point In?" is displayed.
5	Press the ENTER button again at the position where you want to stop erasing (point B). • The section which is to be erased is played and "Position OK?" is displayed. • The section at which the track is to be combined is played repeatedly for several seconds.
6	To fine-adjust point A, turn the jog dial on the main unit or use the automatic search buttons (◀◀ and ▶▶) on the remote control unit to move point A. • "A Point ± [point number]" is displayed. • Fine-adjustment is possible within the range of -178 to +178 points (1 point equals approximately 0.012 seconds).
7	Press the ENTER button to reset point A. • "B Point ± [point number]" is displayed.
8	To fine-adjust point B, turn the jog dial on the main unit or use the automatic search buttons (◀◀ and ▶▶) on the remote control unit to move point B. • "B Point ± [point number]" is displayed. • Fine-adjustment is possible within the range of -178 to +178 points (1 point equals approximately 0.012 seconds).
9	Press the ENTER button. • "Position OK?" is displayed. • The section at which the track is to be combined is played repeatedly for several seconds.
10	Press the ENTER button to erase the A-B section. • "Complete" is displayed.
11	Press the EJECT button (▲). • The TOC data is written and the disc is ejected. • When TOC writing starts, the [TDC] indicator flashes. Do not shake the main unit, press the main unit's POWER button or unplug the power cord while the TOC is being written. If the data is not recorded properly, it will not be possible to play the disc. • The TOC data can also be written by setting the power to the standby mode by pressing the power button on the remote control unit.

• Press the CLEAR button to reset the settings to as they were one step before that point.
 • To cancel the erasing procedure, press the STOP or CLEAR button before step 10 above.

(1) Dividing tracks

- A recorded track can be divided, adding a new track number to the second part.
- Use the function to add a track number at the desired position to make it easy to search for that position.

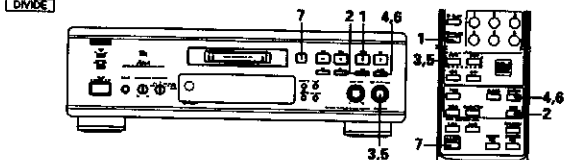

1	Press the PAUSE button at the position at which you want to divide the track.
2	Press the EDIT button. • "Edit Mode" is displayed.
3	Either turn the jog dial on the main unit or press one of the automatic search buttons ([] and []) on the remote control unit. • Display "Divide?".
4	Press the ENTER button. • The position at which the track is to be divided is played and "Position OK?" is displayed. • The section at which the tracks have been combined is played repeatedly for several seconds.
5	To fine-adjust the divide position, turn the jog dial on the main unit or use the automatic search buttons ([] and []) on the remote control unit to move the position. • "Position a [point number]" is displayed. • Fine-adjustment is possible within the range of -255 to +255 points. (1 point equals approximately 0.012 seconds.)
6	Press the ENTER button to divide the track. • "Complete" is displayed.
7	Press the EJECT button ([]). • The TOC data is written and the disc is ejected. • When TOC writing starts, the " [] " indicator flashes. Do not shake the main unit, press the main unit's POWER button or unplug the power cord while the TOC is being written. If the data is not recorded properly, it will not be possible to play the disc. • The TOC data can also be written by setting the power to the standby mode by pressing the power button on the remote control unit.

• If a titled track is divided, both parts will have the same title.
• To put a divided track back together, see "(2) Combining tracks" on Page 20.
• To cancel the dividing procedure, press the STOP or CLEAR button before step 6 above.

(2) Combining tracks

- Use the function to combine two adjacent tracks.

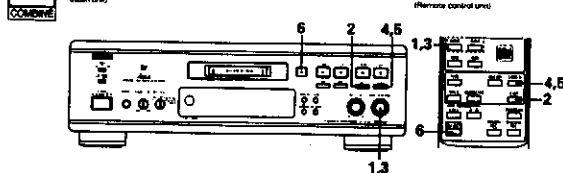

1	In the stop mode, display the number of the second of the adjacent tracks. • Either turn the jog dial on the main unit or use the automatic search buttons ([] and []) on the remote control unit to display the number of the second track.
2	Press the EDIT button. • "Edit Mode" is displayed.
3	Either turn the jog dial on the main unit or press one of the automatic search buttons ([] and []) on the remote control unit. • Display "Combine?".
4	Press the ENTER button. • The tracks to be combined are played and "Combine OK?" is displayed. • The section at which the tracks have been combined is played repeatedly for several seconds.
5	Press the ENTER button to combine the tracks. • "Complete" is displayed.
6	Press the EJECT button ([]). • The TOC data is written and the disc is ejected. • When TOC writing starts, the " [] " indicator flashes. Do not shake the main unit, press the main unit's POWER button or unplug the power cord while the TOC is being written. If the data is not recorded properly, it will not be possible to play the disc. • The TOC data can also be written by setting the power to the standby mode by pressing the power button on the remote control unit.

• To divide tracks that have been combined, see "(1) Dividing tracks" on Page 20.
• Tracks can also be combined in the same way during the play or pause modes by pressing the EDIT button. In the case, the track at which the pause mode is set is combined with the track before it.
• The title of the combined track is the title of the first of the two tracks. If the first track has no title, the title of the second track is used.
• To cancel the combining procedure, press the STOP or CLEAR button before step 6 above.

NOTES:

- Tracks recorded from CDs or MiniDiscs using the digital inputs cannot be combined with tracks recorded using the analog inputs.
- It is not possible to combine a track recorded in stereo with a track recorded in monoaural.
- It may not be possible to combine short tracks less than 15 seconds long.

20

(4) Moving tracks

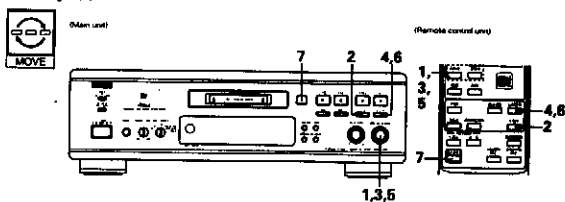

1	In the stop mode, display the number of the track to be moved. • Either turn the jog dial on the main unit or use the automatic search buttons ([] and []) on the remote control unit to display the number of the track to be moved.
2	Press the EDIT button. • "Edit Mode" is displayed.
3	Either turn the jog dial on the main unit or press one of the automatic search buttons ([] and []) on the remote control unit. • Display "Move?".
4	Press the ENTER button. • Display "OO? Move OOR?".
5	Either turn the jog dial on the main unit or use the automatic search buttons ([] and []) on the remote control unit to specify the number to which the track is to be moved.
6	Press the ENTER button to move the track. • "Complete" is displayed.
7	Press the EJECT button ([]). • The TOC data is written and the disc is ejected. • When TOC writing starts, the " [] " indicator flashes. Do not shake the main unit, press the main unit's POWER button or unplug the power cord while the TOC is being written. If the data is not recorded properly, it will not be possible to play the disc. • The TOC data can also be written by setting the power to the standby mode by pressing the power button on the remote control unit.

• To cancel the moving procedure, press the STOP or CLEAR button before step 6 above.

(5) Rearranging the tracks in programmed order

- This function comes in handy when you want to rearrange the order of the tracks recorded on the MiniDisc.

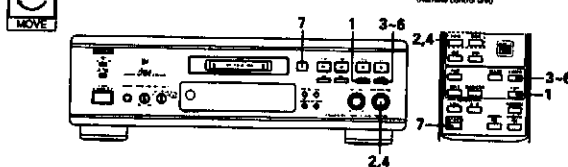

1	In the stop mode, press the EDIT button. • "Edit Mode" is displayed.
2	Either turn the jog dial on the main unit or press one of the automatic search buttons ([] and []) on the remote control unit. • Display "Program Move?".
3	Press the ENTER button. • "New OTr<-->" is displayed, and the mode for programming a new track as the first track is set.
4	Turn the jog dial on the main unit or use the automatic search buttons ([] and []) or the number buttons on the remote control unit then press the ENTER button to program the track to be moved. • For example, to make the track which is currently track the first track, specify "3". "New OTr<-->" is displayed. When the ENTER button is pressed, the mode for setting the next track is set and "New OTr<-->" is displayed. • To continue programming more tracks, repeat steps 3 and 4.
5	Press the ENTER button. • To enter the settings programmed in steps 3 and 4, press the ENTER button while "New OTr<-->" is displayed.
6	Press the ENTER button while "Prog. Move OK?" is displayed to enter the new program. • "Complete" is displayed.
7	Press the EJECT button ([]). • The TOC data is written and the disc is ejected. • When TOC writing starts, the " [] " indicator flashes. Do not shake the main unit, press the main unit's POWER button or unplug the power cord while the TOC is being written. If the data is not recorded properly, it will not be possible to play the disc. • The TOC data can also be written by setting the power to the standby mode by pressing the power button on the remote control unit.

• Up to 25 tracks can be specified.
• Press the CLEAR button at step 5 to clear the track number which was last programmed.
• Press the CALL button at step 6 to check the contents of the program.
• To cancel the moving procedure, press the STOP or CLEAR button before step 6 above.

NOTES:

- Tracks which have not been programmed are placed after the programmed tracks.
- It is not possible to program the same track twice.

21

2. Adding titles

* Up to 100 characters can be input for the track and disc titles

(1) Adding disc titles

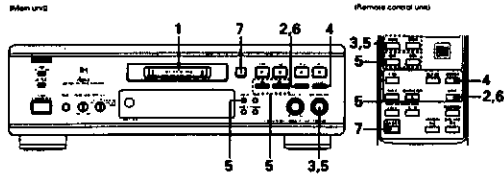

1	Load the disc to which you want to give a title.
2	In the stop mode, press the EDIT button. * "Edit Mode" is displayed.
3	Either turn the jog dial on the main unit or use the automatic search buttons (◀◀ and ▶▶) on the remote control unit to display "Disc Name In?".
4	Press the ENTER button. * The cursor flashes, indicating the title input standby mode.
5	Input the title. * Either turn the jog dial on the main unit or use the automatic search buttons (◀◀ and ▶▶) on the remote control unit to select the desired character. * Some characters that can be input on the DMD-1000 cannot be displayed on other models. * The shape of the cursor changes each time the CHARACTER button is pressed. [Explanation of cursor] <div style="display: flex; justify-content: space-around;"> <div style="border: 1px solid black; padding: 2px;"> </div> <div style="border: 1px solid black; padding: 2px;"> </div> </div> [Available characters and numbers] Capital letter/number input mode ABCDEFGHIJKLMNOPQRSTUVWXYZ0123456789 Small letter/number input mode: abcdefghijklmnopqrstuvwxyz0123456789 Special character input mode: Space * % & * () ^ _ / : ; < > ? @ [\] - * When the manual search forward button (▶▶) or the ENTER button is pressed, the selected character is set, and the unit is set to the input standby mode for the next character. * The cursor can be moved back by pressing the manual search reverse button (◀◀). Use this to correct input characters.
6	Press the EDIT button to enter the input title. * The set disc title scrolls on the display.

7	Press the EJECT button (⏏). * The TOC data is written and the disc is ejected. * When TOC writing starts, the " [TOC] " indicator flashes. Do not shake the main unit, press the main unit's POWER button or unplug the power cord while the TOC is being written. If the data is not recorded properly, it will not be possible to play the disc. * The TOC data can also be written by setting the power to the standby mode by pressing the power button on the remote control unit. * To erase a character, move the cursor to that character then press the CLEAR button. * To correct a character, first erase it, then input the correct character.
---	---

(2) Adding track titles

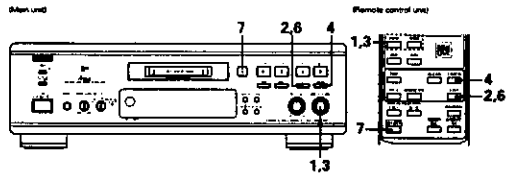

1	In the stop mode, either turn the jog dial on the main unit or use the automatic search buttons (◀◀ and ▶▶) on the remote control unit to display the track number.
2	Press the EDIT button. * "Edit Mode" is displayed. * In the play, pause or recording modes, press the EDIT button to give a title to the current track.
3	Either turn the jog dial on the main unit or use the automatic search buttons (◀◀ and ▶▶) on the remote control unit to display "Track Name In?".
4	Press the ENTER button. * The cursor flashes, indicating the title input standby mode.
5	Input the title. * For instructions on entering titles, see step 5 under "Adding disc titles" on Page 22.
6	Press the EDIT button to enter the input track title.
7	Press the EJECT button (⏏). * The TOC data is written and the disc is ejected. * When TOC writing starts, the " [TOC] " indicator flashes. Do not shake the main unit, press the main unit's POWER button or unplug the power cord while the TOC is being written. If the data is not recorded properly, it will not be possible to play the disc. * The TOC data can also be written by setting the power to the standby mode by pressing the power button on the remote control unit. * In the play or recording mode, finish adding the title before the track ends. If the track changes, the characters that have been input up to that point are no longer valid. * Characters input in the recording pause mode are cleared when the STOP button is pressed.

NOTE:
 * Up to 100 characters can be input for the track and disc titles. "Name Full" is displayed if you attempt to input a 101st character.
 * If the title operation is performed with a disc containing titles with over 100 characters input on another MiniDisc recorded, the characters over the 100th character are erased.
 * A total of approximately 1700 characters can be input for all disc and track titles. "Name Full" is displayed if you attempt to input more characters.

22

3. Erasing titles

* Use this function to change or erase track and disc titles

(1) Erasing disc titles

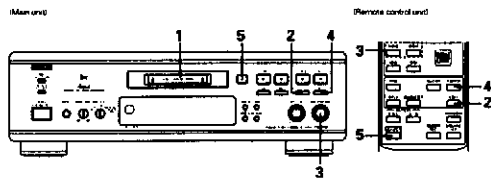

1	Insert the MiniDisc whose title you want to erase into the disc insertion slot.
2	Press the EDIT button in the stop mode while the total number of tracks is displayed. * "Edit Mode" is displayed.
3	Either turn the jog dial on the main unit or press one of the automatic search buttons (◀◀ and ▶▶) on the remote control unit. * Display "D. Name Erase?".
4	Press the ENTER button to erase the disc name. * "Complete" is displayed.
5	Press the EJECT button (⏏). * The TOC data is written and the disc is ejected. * When TOC writing starts, the " [TOC] " indicator flashes. Do not shake the main unit, press the main unit's POWER button or unplug the power cord while the TOC is being written. If the data is not recorded properly, it will not be possible to play the disc. * The TOC data can also be written by setting the power to the standby mode by pressing the power button on the remote control unit.

4	Press the ENTER button to erase the track name. * "Complete" is displayed.
5	Press the EJECT button (⏏). * The TOC data is written and the disc is ejected. * When TOC writing starts, the " [TOC] " indicator flashes. Do not shake the main unit, press the main unit's POWER button or unplug the power cord while the TOC is being written. If the data is not recorded properly, it will not be possible to play the disc. * The TOC data can also be written by setting the power to the standby mode by pressing the power button on the remote control unit.

(2) Erasing all the track titles and the disc title

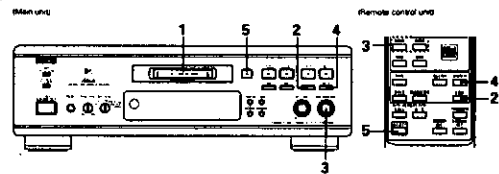

1	Insert the MiniDisc whose disc and track titles you want to erase into the disc insertion slot.
2	Press the EDIT button in the stop mode while the total number of tracks is displayed. * "Edit Mode" is displayed.
3	Either turn the jog dial on the main unit or press one of the automatic search buttons (◀◀ and ▶▶) on the remote control unit. * Display "A. Name Erase?".
4	Press the ENTER button to erase all the track titles and the disc title. * "Complete" is displayed.
5	Press the EJECT button (⏏). * The TOC data is written and the disc is ejected. * When TOC writing starts, the " [TOC] " indicator flashes. Do not shake the main unit, press the main unit's POWER button or unplug the power cord while the TOC is being written. If the data is not recorded properly, it will not be possible to play the disc. * The TOC data can also be written by setting the power to the standby mode by pressing the power button on the remote control unit.

(2) Erasing track titles

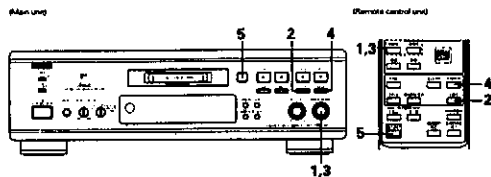

1	Turn the jog dial on the main unit or use the automatic search buttons (◀◀ and ▶▶) on the remote control unit to display the number of the track whose title you want to erase.
2	Press the EDIT button in the stop mode while the number of the track whose title you want to erase is displayed. * "Edit Mode" is displayed.
3	Either turn the jog dial on the main unit or press one of the automatic search buttons (◀◀ and ▶▶) on the remote control unit. * Display "T. Name Erase?".

4. Undoing the last editing operation

Undo Function

* With this function you can undo the editing operation last performed and reset the settings to as they were one step before that point. This comes in handy if you make a mistake when editing.

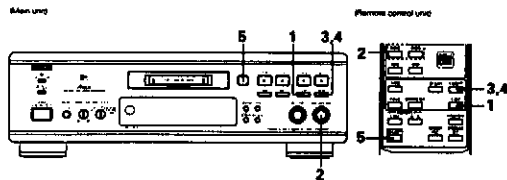

1	In the stop mode, press the EDIT button. • "Edit Mode" is displayed.
2	Either turn the jog dial on the main unit or press one of the automatic search buttons (◀◀ and ▶▶) on the remote control unit. • Display "Undo?" • "Undo?" is not displayed if no editing operation has been performed or if the undo operation is not possible. • The undo function cannot be used in the following cases: • Once the TOC data has been rewritten • Once you have recorded or edited something new • After a power failure • After the undo operation has been used once • When a title has been input in a mode other than the stop mode • When the disc recovery function has been used
3	Press the ENTER button. • One of the following messages appears, depending on the type of editing operation last performed: • When a track or disc title has been input or changed → "Name Undo?" • When a track title, disc title, a single track, all tracks or part of a track has been erased → "Erase Undo?" • When a track has been divided → "Divide Undo?" • When tracks have been combined → "Combine Undo?" • When the move or program move function has been used → "Move Undo?"
4	Press the ENTER button to clear the editing. • "Complete" is displayed.
5	Press the EJECT button (⏏). • The TOC data is written and the disc is ejected. • When TOC writing starts, the "TOC" indicator flashes. Do not shake the main unit, press the main unit's POWER button or unplug the power cord while the TOC is being written. If the data is not recorded properly, it will not be possible to play the disc. • The TOC data can also be written by setting the power to the standby mode by pressing the power button on the remote control unit.

• To set back to the previous setting, press the CLEAR button.
• To cancel the undo operation, press the stop (■ STOP) or CLEAR button before step 4.

5. Reorganizing the MiniDisc's TOC data

Disc Recovery Function

* When recording or editing has been performed repeatedly, the recordable time may be shorter than the MiniDisc's maximum recording time. If this happens, the contents data (TOC) can be partially reorganized to recover some of lost space.

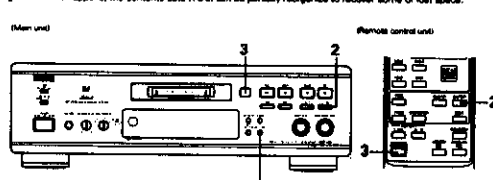

1	In the stop mode, press the RECOVERY button. • "D. Recovery OK" is displayed.
2	Press the ENTER button. • "Complete" is displayed.
3	Press the EJECT button (⏏). • The TOC data is written and the disc is ejected. • When TOC writing starts, the "TOC" indicator flashes. Do not shake the main unit, press the main unit's POWER button or unplug the power cord while the TOC is being written. If the data is not recorded properly, it will not be possible to play the disc. • The TOC data can also be written by setting the power to the standby mode by pressing the power button on the remote control unit.

• The disc recovery function is activated automatically when the single track erase or A-B erase editing operation is performed.

NOTE:
• Due to MiniDisc limitations, the recordable time may not increase with some MiniDiscs.
• This function reorganizes the contents data (TOC). It does not rewrite the audio data.

13 USING THE EXTERNAL INPUT MONITOR

* This function lets you monitor the external input data being input to the different input jacks using the output jacks

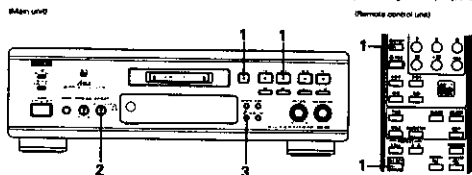

1	Press the EJECT button to eject the MiniDisc or press the STOP button to stop playback.
2	Select the input signal to be monitored using the input select switch.
3	Press the EXT. MONITOR button. • "Ext. Monitor" is displayed and the selected input signal is output to the output jacks. • "Ext. OOKHz" is displayed when a digital input signal is selected, and "Ext. Analog" is displayed when an analog input signal is selected ("OOKHz" indicates the sampling frequency of the digital input signal). • If a digital input signal is selected, "Ext. Monitor" is displayed and the "EXT" indicator is flashing, the digital input signal is not locked. In this case, check the connections, referring to "Connections" on Page 6.

• To stop the external input monitor, press the external input monitor (EXT. MONITOR) again. The external input monitor is also stopped when playback is started or another operation is performed.

14 MESSAGES

Messages may appear on the display while using the DMD-1000. The meanings of these messages are explained below.

Message	Meaning
TOC Reading	TOC is being read.
Blank Disc	Nothing is recorded on the loaded disc.
Complete	Editing is completed.
Copy Prohibit	The SCMS (Serial Copy Management System) prohibits digital copying of that source.
Digital Unlock	During digital recording, this indicates that signals are not being input properly due to incomplete connections of the digital input jacks, etc.
Disc Err #	Disc is scratched. No TOC is written on the MiniDisc or the data is defective.
Disc Full	There is no remaining time on the disc. There are already 255 tracks on the disc.
Impossible	This indicates that the editing operation is not possible.
No Name	This means that no title has been input.
No Track	The disc has a title but no tracks on it.
Playback Only	This appears when you try to record or edit on a disc for playback only.
Protected	The disc is protected against accidental erasure.
Name Full	100 characters have already been input for the disc or track title. Approx. 1700 characters have already been input for the disc and track titles.
TrackProtected	This track cannot be edited.
Disc ?	Data is defective. MiniDisc does not conform to standards.
TOC Err #	Disc is scratched. TOC data cannot be read. MiniDisc does not conform to standards.
Can't REC	Proper recording was not possible due to shocks or scratched disc.
Temp Over	Temperature is too high.
Defect	Recording is interrupted due to scratched disc.
Mech Err #	MiniDisc is not functioning properly.
Not Audio	Non-audio data is recorded on the disc.
UTOC W Err	Proper TOC data could not be created due to scratched disc.
UTOC Err #	TOC data recorded on the disc is not to MiniDisc standards or cannot be read.
Focus Err	Disc is scratched. Player is being used in a shaky, unstable place.

(*) indicates a letter or character!

16 SYSTEM LIMITATIONS

The recording method used on MiniDisc (MD) systems is different from conventional recording methods. Because of this, there are several system limitations.
Note that the following are not malfunctions.

1. Track number limitations

- Up to 255 tracks can be recorded on blank discs or discs with no tracks on them when the tracks are recorded in order starting from track 1. If a disc has been edited repeatedly, however, it may not be possible to record 255 tracks on the disc.
- If there is an eraseless data or other signals between tracks during digital recording, this will be treated as a break within the track (the track number will not change), and recording may not be possible, regardless of the recording time or number of tracks.

2. Recording limitations

- If 255 tracks are already recorded on the disc, no further recording is possible, even if the recorded time is less than the maximum recordable time.
- Recording is performed in units of about 2 seconds. About 2 seconds of disc space is used even if the section is less than 2 seconds long. That is, the actual recordable time becomes shorter.
- If there are scratches on the disc, recording is not possible in the scratched sections, and the recordable time decreases accordingly. ("Defect" is displayed during recording and the number of tracks on the MiniDisc is automatically increased.)
- When digitally recording CDs, depending on the recording on the CD blank sections of several seconds may be created and the number of tracks may differ from the number on the original CD.
- When the analog A.T.M. function is on and track numbers are added automatically, the track numbers may not be added properly, depending on the original recording.
- In some cases, the remaining time may not decrease when short tracks are erased. This is because sections of 12 seconds and less are ignored when displaying the remaining time on the MD.

3. Editing limitations

- In some cases it is not possible to combine short tracks created through editing.
- There may be breaks in the sound during manual search on MiniDiscs which have been recorded or edited repeatedly.

16 TROUBLESHOOTING

Check the following before assuming there is a problem with the unit.

- Are connections proper?
- Are you operating as described in these operating instructions?
- Be sure to check that the main power switch on the rear panel is turned on.

If the unit does not seem to be operating properly, check the items listed on the table below. If the cause of the problem cannot be found, this unit may be malfunctioning. Immediately turn off the power and unplug the power cord, then contact your store of purchase or your nearest Denon dealer.

Problem	Cause	Measure	Page
Set does not operate.	<ul style="list-style-type: none"> The disc is loaded. Disc is damaged or dirty. 	<ul style="list-style-type: none"> Load a disc. Replace with another disc. 	5
Disc does not play.	<ul style="list-style-type: none"> Connections are wrong. Nothing is recorded on the disc ("Blank Disc" or "No Track" is displayed). 	<ul style="list-style-type: none"> Check the connections. Replace with a recorded disc. 	6 25
Recording is not possible.	<ul style="list-style-type: none"> Disc is protected ("Protected" is displayed). There is no remaining time on the disc ("Disc Full" is displayed). 255 tracks are already recorded on the disc ("Disc Full" is displayed). You are attempting to digitally record a digitally recorded source (See the description of the SCMS system) ("Copy Prohibit" is displayed). The input selector (INPUT SELECT) is not set properly. The INPUT LEVEL control is turned down. 	<ul style="list-style-type: none"> Move the disc's accidental erasure protection cap to open the hole. Replace the disc. If there are any sections you do not need, erase them to increase the recording time. Replace the disc. If there are any tracks you do not need, erase them to increase the recording time. Use Inhibit recording. Check the recording input mode. Adjust the INPUT LEVEL control for analog recording only. 	5, 25 26 26 13, 26 13 13

17 MAIN SPECIFICATIONS

Type:	MiniDisc digital audio system
Wow & flutter:	Below measurable limits (± 0.001 % W, peak or less)
Sampling frequency:	44.1 kHz
Recording method:	Magnetic modulation overwriting
Light source:	Semiconductor
Signal-to-noise Ratio:	105 dB
Dynamic Range:	98 dB
Power supply:	AC 120 V, 60Hz (U.S.A. & Canada models) AC 230 V, 50Hz (Europe / U.K. & Asia models)
Power consumption:	20 W
Maximum external dimensions:	434 (width) x 134 (height) x 340 (depth) mm (including feet, controls and terminals)
Weight:	6.4 kg
Remote control unit:	RC-270
Remote control method:	Infrared pulse
No. batteries:	3x
Power supply:	DC 3V using two R6P (AA) batteries
Maximum external dimensions:	80 (width) x 177 (height) x 18 (depth) mm (including batteries)
Weight:	100 g

For improvement purposes, specifications and design are subject to change without notice.

"US and foreign patents licensed from Dolby Laboratories Licensing Corporation"

DISASSEMBLY

(Follow the procedure below reverse order when reassembling)

Top Cover

1. Remove 2 screws on the rear, 4 screws on both sides and 4 screws on the top.
2. Detach the Top Cover as shown in the arrow direction.

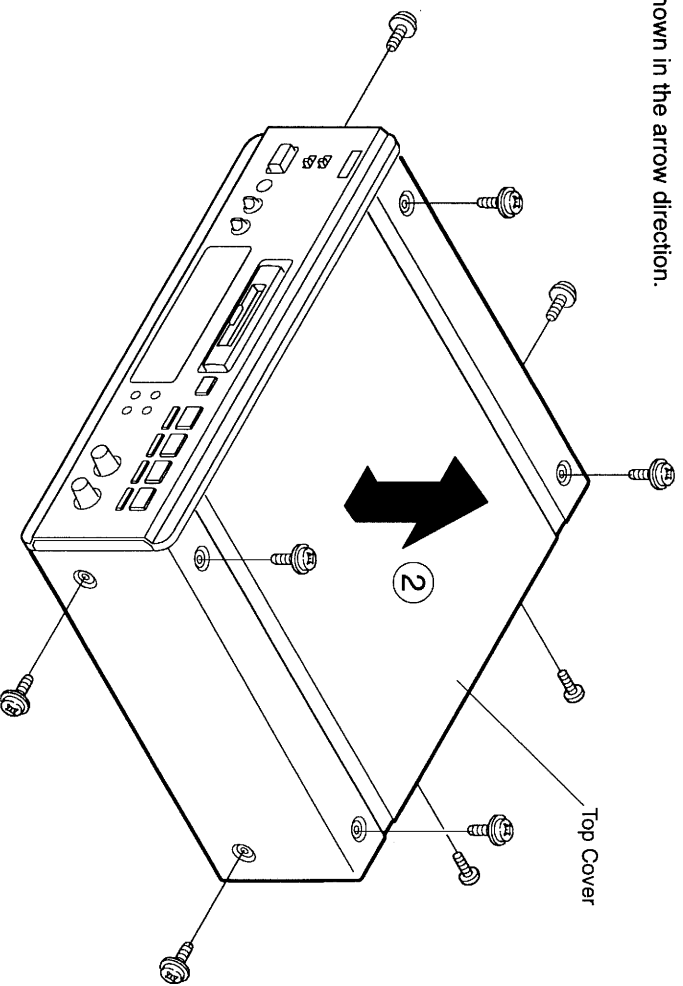

Rear Panel

5. Remove the cord bush from the Rear Panel.
6. Remove 10 screws fixing the Rear Panel.
7. Detach the Rear Panel in the arrow direction.

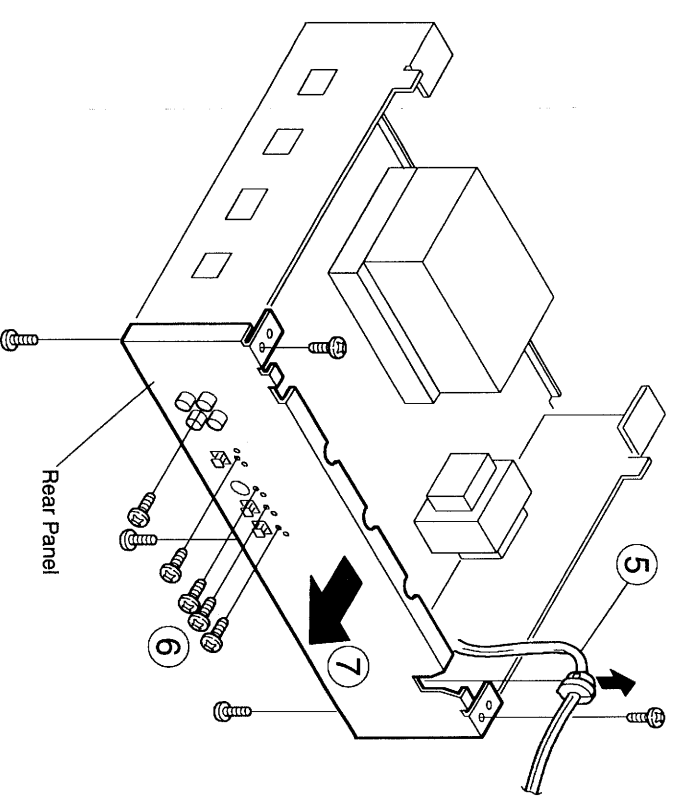

MD Unit

8. Remove 4 screws fixing the MD Unit.
9. Detach the MD Unit in the arrow direction.

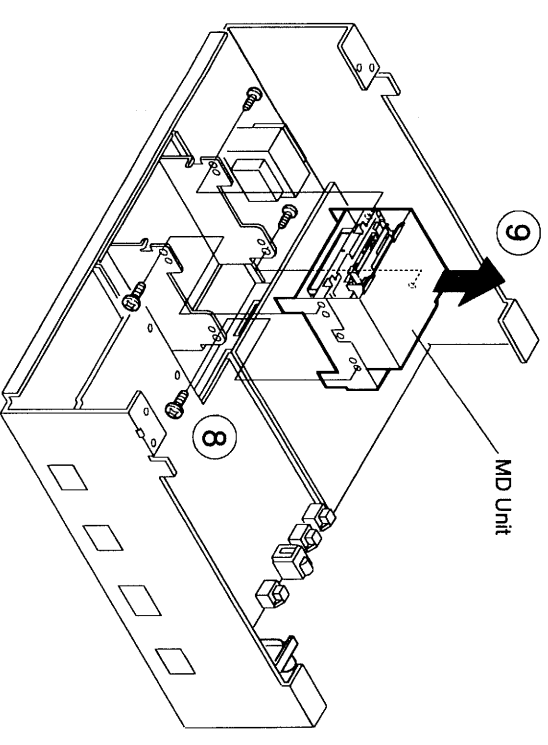

Front Panel

3. Remove 2 upper screws and 3 lower screws.
4. Detach the Front Panel in the arrow direction.

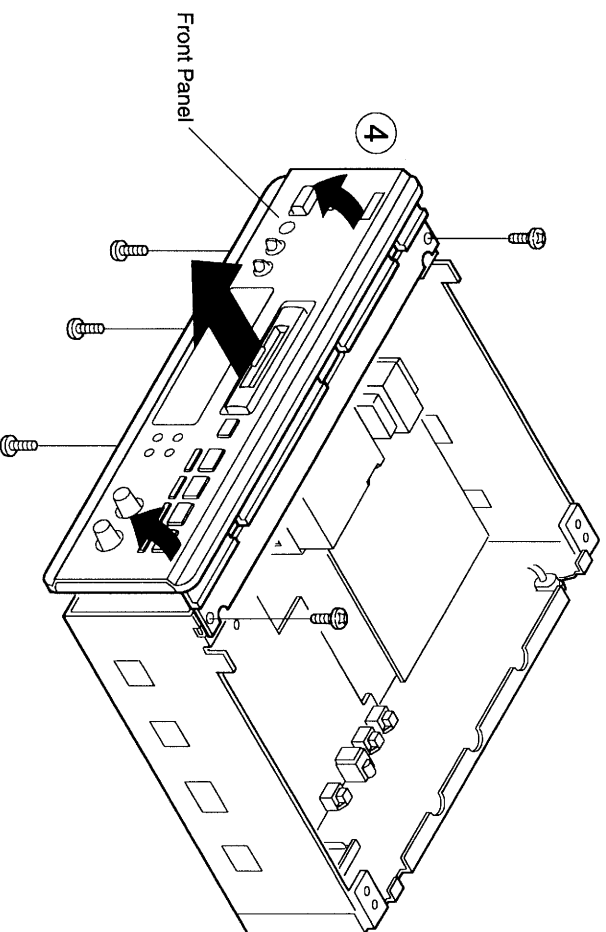

ADJUSTMENT

● PREPARATION

Required Test Disc

	Type	Test Disc
1	High reflection disc	TGYSI (SONY) for playback
2	Low reflection disc	Mini disc for recording
3	—	Transparent disc for head alignment

● TEST MODE

Setting the Test Mode

Load the disc 1 (high reflection disc) for playback or the disc 2 (low reflection disc). Short-circuit between J209 and J210 on the main P.W.B. in the OFF state of the power supply, then turn the power supply switch ON to indicate that the set is in the test mode as the following. Release J209 and J210 from the short-circuit after getting in the test mode.

Microcomputer version display tsm@@*# (all MD microcomputer version)

@@ : model code.
 *# : microcomputer ROM version (from 01).
 !! : EEPROM protect data version (from 01).

↓
 "LOADING"

↓
 "AUT YOBI"

Cancelling the Test Mode

Press the power supply button to OFF or pull out the AC cord from the wall socket to set in the no power, connect a resistor which is less than 10 ohm at the both ends of C146 for 15~20 sec. When the voltage at the both ends of C146 is less than 2V, turn the power supply ON again to cancel the test mode.

Note: Before turning the power supply ON again, be sure to remove the resistor.

Setting after changing the Pick-up or P.W.B. in the MD Unit

- 1) Short-circuit between the pin 8 (Protect) and 2 (Vcc) of IC1402 (EEPROM) on the P.W.B. in MD Unit.
- 2) Enter into the test mode according to the steps described in "Setting the Test Mode".
- 3) Carry out "AUTO PREPARATION MODE" and "AUTO MODE" in the test mode.
- 4) Press the CHARACTER button.
- 5) If "W. Complete" is displayed, cancel the test mode according to the steps described in "Cancelling the Test Mode". Be sure to undo the short-circuited Pin 8 and 2 of IC1402.

Outline of the Test Mode

1. AUTOYOBI MODE	<ul style="list-style-type: none"> •Carries out automatic pre-adjustment. (After the adjustment, grating adjustment mode)
2. AUTO MODE	<ul style="list-style-type: none"> • Carries out automatic adjustment. • Carries out continuous playback. (Error rate, measurement)
3. RST YOBI MODE	<ul style="list-style-type: none"> •Displays the values of measuring, setting and calculation. •Changes setting value manually. (At the servo OFF)
4. RESULT MODE	<ul style="list-style-type: none"> •Displays setting value after calculation. •Changes setting value manually. (At the servo OFF)
5. MNU YOBI MODE	<ul style="list-style-type: none"> •Carries out RF manual adjustment. •Carries out ATT manual adjustment of focus and tracking signals. •Carries out off-set measurement of focus and tracking signals.
6. MANUAL MODE	<ul style="list-style-type: none"> •Carries out ATT manual adjustment of focus and tracking signals.
7. EEPROM_SET MODE	<ul style="list-style-type: none"> •Changes various coefficients of digital servo manually. •Sets each servo to ON respectively. •Measures temperature detecting pin voltage, and sets reference value.

Contents of the Test Mode

1. AUTOYOBI MODE

Operation Procedure	Display
1. Press the PLAY button from the STOP state of service mode to display as the light-mentioned.	_AUT YOBI_
2. Press the ENTER button to start the AUTO adjustment.	* * * : _
3. When the adjustment is NG, display as the right-mentioned.	Can't_ADJ
4. When the adjustment is OK, displays as the right-mentioned.	_COMPLETE_
5. Press the STOP button to become the AUT YOBI menu state (return to item 1 state).	_AUT YOBI_

*** : adjustment name

2. AUTO MODE

Operation Procedure	Display
1. Press the PLAY button from the STOP state of service mode to display as the light-mentioned.	_AUTO_
2. Press the ENTER button to start the AUTO adjustment.	* * * : _
3. When the adjustment is NG, display as the right-mentioned.	Can't_ADJ.
4. When the adjustment is OK, displays as the right-mentioned.	_COMPLETE_
5. Press the ENTER button to become the continuative playback state when the adjustment is OK.	s□□□□c----
5(a). Continuative playback (pit portion, high reflection disc).	a□□□□c----
5(b). Continuative playback (groove portion, low reflection disc).	
6. Press the EJECT button to display as item 7.	
7. Continuative playback (low reflection disc only, no display changes when hi reflection disc).	a□□□□a----
8. Press the STOP button to become the AUTO menu state (return to item 1 state).	_AUTO_

*** : adjustment name, □□□□ : address name, ---- : C1 error

3. RST YOBI MODE

Operation Procedure	Display
1. Press the PLAY button from the STOP state of service mode to display as the right-mentioned.	_RST_YOBI_
2. Press the ENTER button to display RFG measured value.	RFG: __X
3. Press the PLAY button to display RCG measured value.	RCG: __X
4. Press the PLAY button to display PTG set value.	PTG: __X
5. Press the PLAY button to display GTG set value.	GTG: __X
6. Press the PLAY button to display PCH set value.	PCH: __XX
7. Press the PLAY button to display GCH set value.	GCH: __XX
8. Press the PLAY button to display SAG set value.	SAG: __XXX
9. Press the PLAY button to display SBG set value.	SBG: __XXX
10. Press the PLAY button to display SEG set value.	SEG: __XXX
11. Press the PLAY button to display SFG set value.	SFG: __XXX
12. Press the PLAY button to display HA0 set value.	HA0:000__
13. Press the PLAY button to display HB0 set value.	HB0:000__
14. Press the PLAY button to display HE0 set value.	HE0:000__
15. Press the PLAY button to display HF0 set value.	HF0:000__
16. Press the PLAY button to display LA0 set value.	LA0:000__
17. Press the PLAY button to display LB0 set value.	LB0:000__
18. Press the PLAY button to display LE0 set value.	LE0:000__
19. Press the PLAY button to display LF0 set value.	LF0:000__
20. Press the PLAY button to display TC0 set value.	TC0:000__
21. Press the PLAY button to display YOB (sequence No. of adjust error display).	YOB: \$\$__
22. Press the PLAY button to display DIF (adjusting state display).	DIF: \$\$__
23. Press the PLAY button to display ADJ (pre-adjust unfinish/00 or finish/4B).	ADJ: \$\$__
24. Press the STOP button to become the RST YOBI menu state (return to item 1 state).	_RST_YOBI_

0 : measured value, X : set value, \$: various data

Change the set value with the Automatic Search key while the set value displayed.

4. RESULT MODE

Operation Procedure	Display
1. Press the PLAY button from the STOP state of service mode to display as the right-mentioned.	__RESULT__
2. Press the ENTER button to display HAG measured value.	HAG: __XXX
3. Press the PLAY button to display HBG measured value.	HBG: __XXX
4. Press the PLAY button to display LAG set value.	LAG: __XXX
5. Press the PLAY button to display LBG set value.	LBG: __XXX
6. Press the PLAY button to display PEG set value.	PEG: __XXX
7. Press the PLAY button to display PFG set value.	PFG: __XXX
8. Press the PLAY button to display GEG set value.	GEG: __XXX
9. Press the PLAY button to display GFG set value.	GFG: __XXX
10. Press the PLAY button to display GCG set value.	GCG: __XXX
11. Press the STOP button to become the RESULT menu state (return to item 1 state).	__RESULT__

X : set value

Change the set value with the Automatic Search key while the set value displayed.

5. MNU YOBI MODE

Operation Procedure	Display
1. Press the PLAY button from the STOP state of service mode to indicate as the right-mentioned.	_MNU_YOBI_
2. Press the ENTER button to display TEMP measured value.	TEMP: 00__
3. Press the PLAY button to display HA0 temporarily measured value (A signal off-set).	HA0: 000__
4. Press the PLAY button to display HB0 temporarily measured value (B signal off-set).	HB0: 000__
5. Press the PLAY button to display HE0 temporarily measured value (E signal off-set).	HE0: 000__
6. Press the PLAY button to display HF0 temporarily measured value (F signal off-set).	HF0: 000__
7. Press the PLAY button to turn on Laser and to indicate the right-mentioned.	LON: _____
8. Press the PLAY button to set RFg coarsely (RF side FG).	RFg:000__X
9. Press the PLAY button to set SAg coarsely (Focus ATT/A signal).	SAg:000\$\$\$
10. Press the PLAY button to set SBg coarsely (Focus ATT/B signal).	SBg:000\$\$\$
11. Press the PLAY button to adjust PTG (RF side pit portion TG).	PTG:000__X
12. Press the PLAY button to set PCH (pit portion COUT level).	PCH:000__\$
13. Press the PLAY button to adjust GTG (RF side groove portion TG).	GTG:000__X
14. Press the PLAY button to set GCH (groove portion COUT level).	GCH:000__\$
15. Press the PLAY button to adjust RCG (RF side TCRS).	RCG:000__X
16. Press the PLAY button to set SEG (Tracking ATT/A signal).	SEG:000\$\$\$
17. Press the PLAY button to set SFG (Tracking ATT/B signal).	SFG:000\$\$\$
18. Press the PLAY button to display gMI measured value (Tracking EFMIO).	Gml:000__
19. Press the PLAY button to adjust RFG (RF side pit portion FG).	RFG:000__X
20. Press the PLAY button to set SAG (Focus ATT/A signal).	SAG:000\$\$\$
21. Press the PLAY button to set SBG (Focus ATT/B signal).	SBG:000\$\$\$
22. Press the PLAY button to display HA0 measured value (A signal off-set).	HA0:000__
23. Press the PLAY button to display HB0 measured value (B signal off-set).	HB0:000__
24. Press the PLAY button to display HE0 measured value (E signal off-set).	HE0:000__
25. Press the PLAY button to display HF0 measured value (F signal off-set).	HF0:000__
26. Press the PLAY button to display TC0 measured value (TRCS signal off-set).	TC0:000__
27. Press the PLAY button to display LA0 measured value (A signal off-set).	LA0:000__
28. Press the PLAY button to display LB0 measured value (B signal off-set).	LB0:000__
29. Press the PLAY button to display LE0 measured value (E signal off-set).	LE0:000__
30. Press the PLAY button to display LF0 measured value (F signal off-set).	LF0:000__
31. Press the STOP button to become MNU YOBI menu state (return to item 1 state).	_MNU_YOBI_

0 : measured value, X : set value, \$: calculated value

Change the set value with the Automatic Search key while the set value displayed.

※ When ☆ mark appeared after the set value (8th character), it indicates that the adjusted value comes within an allowable range.

6. MANUAL MODE

6-1. Low reflection disc

Operation Procedure	Display
1. Press the PLAY button from the STOP state of service mode to indicate as the right-mentioned.	_MNU_AJST_
2. Press the ENTER button to display TEMP measured value.	TMP:_00__
3. Press the PLAY button to light laser and display as the right-mentioned.	LON:____
4. Press the PLAY button to set PEG (Tracking ATT/E signal).	PEG:000__
5. Press the PLAY button to set PFG (Tracking ATT/F signal).	PFG:000__
6. Press the PLAY button to display PMI measured value (Tracking EFMIO).	PMI:000__
7. Press the PLAY button to set LAg (Focus ATT/A signal).	LAg:000__
8. Press the PLAY button to set LBg (Focus ATT/B signal).	LBg: ____
9. Press the PLAY button to set GCG (Track cross).	GCG:000_X
10. Press the PLAY button to set GEG (Tracking ATT/E signal).	GEG:000\$\$\$
11. Press the PLAY button to set GFG (Tracking ATT/F signal).	GFG:000\$\$\$
12. Press the PLAY button to display GMI measured value (Tracking EFMIO).	GMI:000_\$\$
13. Press the PLAY button to set LAG (Focus ATT/A signal).	LAG:000_\$\$
14. Press the PLAY button to set LBG (Focus ATT/B signal).	LBG:000_X
15. Press the STOP button to become the MNU AJST menu state (return to item 1 state).	_MNU_AJST_

0 : measured value, X : set value, \$: calculated value

Change the set value with the Automatic Search key while the set value displayed.

6-2. Low reflection disc

Operation Procedure	Display
1. Press the PLAY button from the STOP state of service mode to indicate as the right-mentioned.	_MNU_AJST_
2. Press the ENTER button to display TEMP measured value.	TMP:_00__
3. Press the PLAY button to light laser and display as the right-mentioned.	LON:____
4. Press the PLAY button to set PEG (Tracking ATT/E signal).	PEG:000XXX
5. Press the PLAY button to set PFG (Tracking ATT/F signal).	PFG:000XXX
6. Press the PLAY button to display PMI measured value (Tracking EFMIO).	PMI:000__
7. Press the PLAY button to set HAG (Focus ATT/A signal).	HAG:000XXX
8. Press the PLAY button to set HBG (Focus ATT/B signal).	HBG:000XXX
9. Press the STOP button to become the MNU AJST menu state (return to item 1 state).	_MNU_AJST_

0 : measured value, X : set value, \$: calculated value

Change the set value with the Automatic Search key while the set value displayed.

7. EEPROM_SET MODE

(a) Setting the Focus

Operation Procedure	Display
1. Press the PLAY button from the STOP state of service mode to display as the right-mentioned.	EEPROM_SET
2. Press the ENTER button to become the focus setting menu state.	__Focus__
3. Press the ENTER button to become the FG setting state.	FG__ \$\$
4. Press the PLAY button to become the FF1 setting state.	FF1__ \$\$
5. Press the PLAY button to become the FF2 setting state.	FF2__ \$\$
6. Press the PLAY button to become the FZHLEV setting state.	FZHLEV_ \$\$
7. Press the PLAY button to become the FOKLEVn setting state.	FOKLEVn_ \$\$
8. Press the PLAY button to become the FOKLEVf setting state.	FOKLEVf_ \$\$
9. Press the PLAY button to become the FOKLPFn setting state.	FOKLPFn_ \$\$
10. Press the PLAY button to become the FOKLPFf setting state.	FOKLPFf_ \$\$
11. Press the PLAY button to become the WAITf setting state.	WAITf_ \$\$
12. Press the STOP button to become the FOCUS setting menu state (return to item 2 state).	__Focus__

0 : measured value, X : set value, \$: calculated value

Change the set value with the Automatic Search key while the set value displayed.

(b) Setting the Spindle

Operation Procedure	Display
1. Press the PLAY button from the STOP state of service mode to display as the right-mentioned.	EEPROM_SET
2. Press the ENTER button to become the focus setting menu state.	__Focus__
3. Press the PLAY button to display as the right-mentioned.	__spindle__
4. Press the ENTER button to become the SPG setting state.	SPG__ \$\$
5. Press the PLAY button to become the SPG in setting state.	SPG_in_ \$\$
6. Press the PLAY button to become the SPG mid setting state.	SPG_mid_ \$\$
7. Press the PLAY button to become the SPG out setting state.	SPG_out_ \$\$
8. Press the PLAT button to become the SP1 setting state.	SP1__ \$\$
9. Press the PLAT button to become the SP2 setting state.	SP2__ \$\$
10. Press the PLAY button to become the SP3 setting state.	SP3__ \$\$
11. Press the PLAY button to become the SP4 setting state.	SP4__ \$\$
12. Press the PLAY button to become the SP5 setting state.	SP5__ \$\$
13. Press the STOP button to become the spindle setting menu state (return to item 3 state).	__spindle__

Change the set value with the Automatic Search key while the set value displayed.

(c) Setting the Tracking

Operation Procedure	Display
1. Press the PLAY button from the STOP state of service mode to display as the right-mentioned.	EEPROM_SET
2. Press the ENTER button to become the focus setting menu state.	__Focus__
3. Press the PLAY button to display as the right-mentioned.	__Tracking__
4. Press the ENTER button to become the TG setting state.	TG__\$
5. Press the PLAY button to become the TF1 setting state.	TF1__\$
6. Press the PLAY button to become the TF2 setting state.	TF2__\$
7. Press the PLAY button to become the TRBLVo setting state.	TRBLVo__\$
8. Press the PLAY button to become the TRBLVt setting state.	TRBLVt__\$
9. Press the PLAY button to become the TRKLVo setting state.	TRKLVo__\$
10. Press the PLAY button to become the TRKLVt setting state.	TRKLVt__\$
11. Press the PLAY button to become the TDPWo setting state.	TDPWo__\$
12. Press the PLAY button to become the TDPWt setting state.	TDPWt__\$
13. Press the PLAY button to become the SLCTo setting state.	SLCTo__\$
14. Press the PLAY button to become the SLCTt setting state.	SLCTt__\$
15. Press the PLAY button to become the SLCTm setting state.	SLCTm__\$
16. Press the PLAY button to become the SVCNT4 setting state.	SVCNT4__\$
17. Press the PLAY button to become the TCRSC1P setting state.	TCRSC1P__\$
18. Press the PLAY button to become the COTLVp setting state.	COTLVp__\$
19. Press the PLAY button to become the COTLVr setting state.	COTLVr__\$
20. Press the STOP button to become the Tracking setting menu state (return to item 3 state).	__Tracking__

\$:set value

Change the set value with the Automatic Search key while the set value displayed.

(d) Setting the Slide

Operation Procedure	Display
1. Press the PLAY button from the STOP state of service mode to display as the right-mentioned.	EEPROM_SET
2. Press the ENTER button to become the focus setting menu state.	__Focus__
3. Press the PLAY button to display as the right-mentioned.	__Sled__
4. Press the ENTER button to become the SLG setting state.	SLG__\$
5. Press the PLAY button to become the SL2 setting state.	SL2__\$
6. Press the PLAY button to become the SLDLIM setting state.	SLDLIM__\$
7. Press the PLAY button to become the SLKLEV setting state.	SLKLEV__\$
8. Press the PLAY button to become the SLKLVk setting state.	SLKLVk__\$
9. Press the PLAY button to become the SLKLVt setting state.	SLKLVt__\$
10. Press the PLAY button to become the SLKLVm setting state.	SLKLVm__\$
11. Press the PLAY button to become the Slide setting menu state (return to item 3 stste).	__Sled__

\$:set value

Change the set value with the Automatic Search key while the set value displayed.

(e) Setting the TEMP

Operation Procedure	Display
1. Press the PLAY button from the STOP state of service mode to display as the right-mentioned.	EEPROM_SET
2. Press the ENTER button to become the focus setting menu state.	__Focus__
3. Press the PLAY button to display as the right-mentioned.	__Temp__
4. Press the ENTER button to become the TEMP setting state.	TEMP_00_\$\$
5. Press the STOP button to become the TEMP setting menu state (return to item 3 state).	__Temp__

0:measured value, \$:set value

Change the set value with the Automatic Search key while the set value displayed.

(f) Setting the Control

Operation Procedure	Display
1. Press the PLAY button from the STOP state of service mode to display as the right-mentioned.	EEPROM_SET
2. Press the ENTER button to become the focus setting menu state.	__Focus__
3. Press the PLAY button to display as the right-mentioned.	__Control__
4. Press the ENTER button to become the CONTROL1 setting state.	CONTROL1_XX
5. Press the PLAY button to become the CONTROL2 setting state.	CONTROL2_XX
6. Press the PLAY button to become the SPKLEVm setting state.	SPKLEVm_XX
7. Press the PLAY button to become the ADJTTM setting state.	ADJTTM_XX
8. Press the PLAY button to become the HDEQAD setting state.	HDEQAD_XX
9. Press the PLAY button to become the LDEQAD setting state.	LDEQAD_XX
10. Press the PLAY button to become the GDEQAD setting state.	GDEQAD_XX
11. Press the PLAY button to become the HDEQBC setting state.	HDEQBC_XX
12. Press the PLAY button to become the LDEQBC setting state.	LDEQBC_XX
13. Press the PLAY button to become the GDEQBC setting state.	GDEQBC_XX
14. Press the PLAY button to become the HALSG setting state.	HALSG_XX
15. Press the PLAY button to become the LALSG setting state.	LALSG_XX
16. Press the PLAY button to become the GALSG setting state.	GALSG_XX
17. Press the PLAY button to become the HALSOFS setting state.	HALSOFS_XX
18. Press the PLAY button to become the LALSOFS setting state.	LALSOFS_XX
19. Press the PLAY button to become the GALSOFS setting state.	GALSOFS_XX
20. Press the STOP button to become the CONTROL setting menu state (return to item 3 state).	__CONTROL__

X:set value

Change the set value with the Automatic Search key while the set value displayed.

(g) Setting the ADJSET

Operation Procedure	Display
1. Press the PLAY button from the STOP state of service mode to display as the right-mentioned.	EEPROM_SET
2. Press the ENTER button to become the focus setting menu state.	__Focus__
3. Press the PLAY button to become the ADJSET setting menu state.	__ADJSET__
4. Press the ENTER button to become the COK setting state.	COK_XX
5. Press the PLAY button to become the FAT setting state.	FAT_XX
6. Press the PLAY button to become the TAT setting state.	TAT_XX
7. Press the PLAY button to become the CAT setting state.	CAT_XX
8. Press the PLAY button to become the FAB setting state.	FAB_XX
9. Press the PLAY button to become the STR setting state.	STR_XX
10. Press the PLAY button to become the SFS setting state.	SFS_XX
11. Press the PLAY button to become the STC setting state.	STC_XX
12. Press the STOP button to become the ADJSET setting menu state (return to item 3 state).	__ADJSET__

X:set value

Change the set value with the Automatic Search key while the set value displayed.

LEAD-IN SWITCH POSITION MEASUREMENT MODE (with Test Disc1)

Measuring with the high reflection disc (Make sure when changing the Mecha. Switch P.W.B.)

Step No.	Setting	Remarks	Display	Display
Step 1	Start test mode	Servo OFF (Power ON)	AUTO	AUTO
Step 2	Push PAUSE button once		No operation with recording discs.	INNER
Step 3	Push PLAY button once	Displays sub-code cluster value of the Lead-in Switch.		『s□□□□c△△△△』

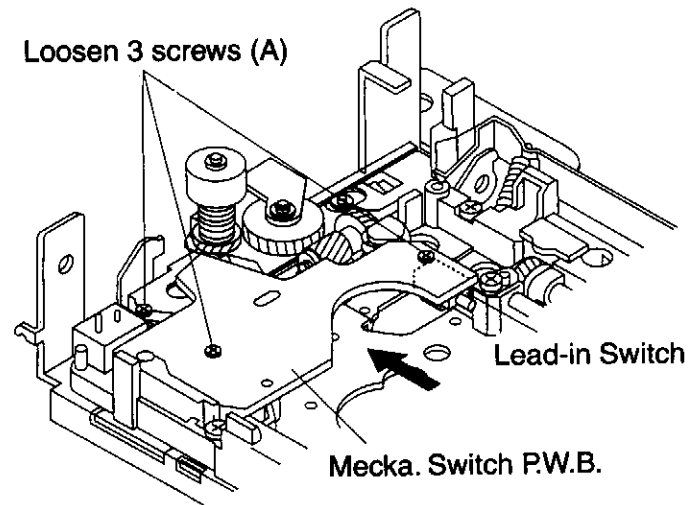

NOTE: Adjust the Lead-in Switch position to SUBQ FF85~FFD2.

1. Loosen 3 screws (A) fixing the Mecha. Switch P.W.B.

2. After tightening the screws with pushing the Mecha. Switch P.W.B. in the arrow direction, measure the Lead-in Switch position again. Fix by the 3 screws (A) after the position adjustment. (See Fig below)

Measuring with the high reflection disc(Make sure when changing the Mecha. Switch P.W.B)

● MAGNETIC HEAD MOUNTING POSITION

- * Be sure to adjust the mounting position whenever the magnetic head or optical pick-up is replaced.
- * In order easier to perform the mounting position adjustment, place the optical pick-up in the center position.

1. Set the transparent disc (Test disc 3).
2. Lower the magnetic head up-shift arm manually to lift the magnetic head.
3. View the unit from the above to confirm that the object lens of pick-up coincides with the magnetic head.

Diameter direction: Slightly loosen the head fastening screw (A) and slide the head fixture to diameter direction so as the head coincides within the object lens of pick-up.

Circle direction: Adjust the head circle direction adjustment screw (B) to fit the head within the object lens.

4. Confirm a gap as in figure and ascertain the head that is moving smoothly.
5. After complete adjustment, apply a screw locking agent on head fastening screw (A) and adjusted head circle direction screw (B).

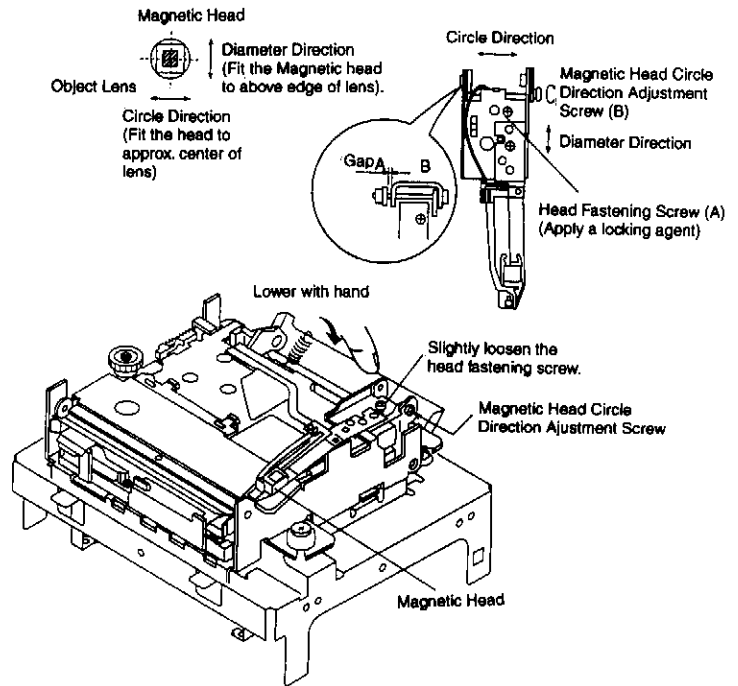

● MECHANISM ADJUSTMENT

Checking the Optical Pick-up Grating

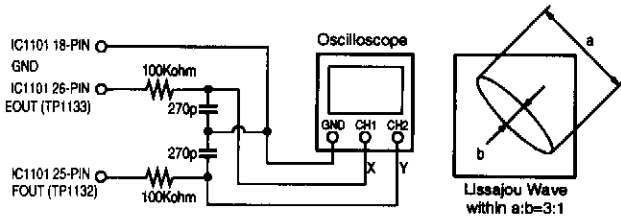

Measuring method of the optical pick-up grating slippage

Adjust the Lissajou wave (X-Y) of EOUT against to FOUT after executing AUTO adjustment in the AUTO mode of test mode with the high reflection disc (displays COMPLETE).

1. Unsolder 2 positions on the disc motor P.W.B., short-circuit with lead wire as shown in the figure between the motor terminal and P.W.B., loosen 3 screws slightly and adjust while observing the Lissajou wave.
2. When completed, tighten these screws in the order of number 1, 2, 3.

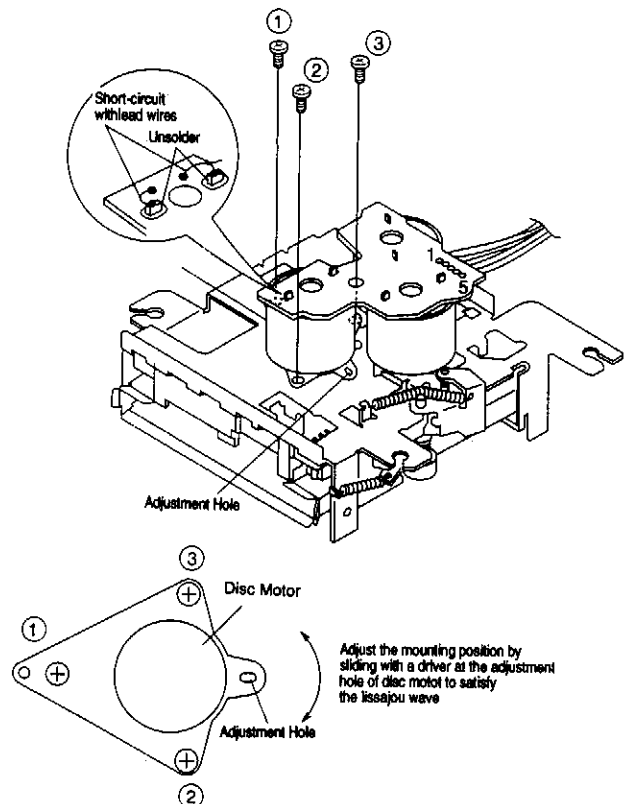

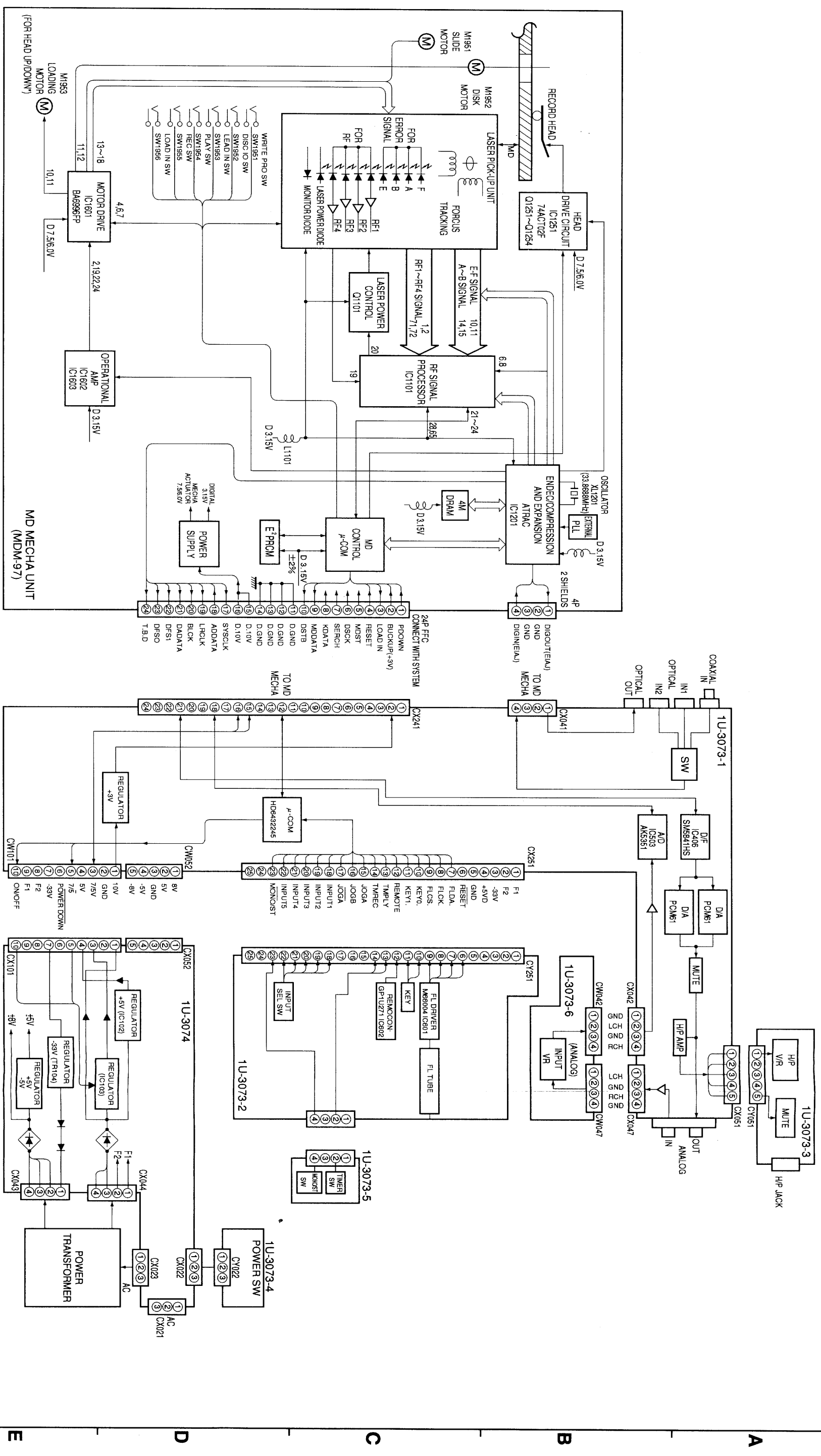

SEMICONDUCTORS

● IC's
HD6432245F10 (IC201)

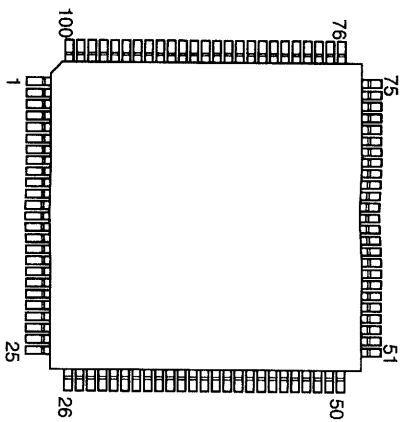

HD6432245F10 Terminal Function

Pin No.	Name	Symbol	I/O	Typ	Rst	Ini	Act	Ext	Function
1	P127/TIOCC0/TCLKA	MONO/ST	I	B	HZ	—	—	P. UP	Recording monaural / stereo switching input pin.
2	P137/TIOCD0/TCLKB	INPUT 1	I	B	HZ	—	—	P. UP	Input signal switching input pin.
3	P147/TIOCA1	INPUT 2	I	B	HZ	—	—	P. UP	Input signal switching input pin.
4	P157/TIOCB1/TCLKC	INPUT 3	I	B	HZ	—	—	P. UP	Input signal switching input pin.
5	P167/TIOCA2	INPUT 4	I	B	HZ	—	—	P. UP	Input signal switching input pin.
6	P177/TIOCB2/TCLKD	INPUT 5	I	B	HZ	—	—	P. UP	Input signal switching input pin.
7	VSS	—	—	—	—	—	—	—	GND connection (GND for system).
8	P30/TXD0	KDATA	O	B	HZ	L	—	P. UP	Serial communication data output pin (communication with drive μ-com).
9	P31/TXD1	DA	I/O	B	HZ	H	—	P. UP	Data In/out pin for signal processing LSI.
10	P32/RXD0	MDDATA	I	B	HZ	L	—	P. UP	Serial communication data input pin (communication with drive μ-com).
11	P33/RXD1	LD	I	B	HZ	H	—	P. UP	Latch enable output pin for signal processing LSI.
12	P34/CSK0/IRQ4	DSCK	O	B	HZ	L	—	P. UP	Serial communication clock signal output pin (communication with drive μ-com).
13	P34/CSK1/IRQ5	CL	O	B	HZ	H	—	P. UP	Clock output pin for signal processing LSI.
14	PE0	DSTB	I	B	HZ	L	—	P. UP	Serial communication request signal input pin (communication with drive μ-com).
15	PE1	DFSO	I	B	HZ	L	—	P. UP	Emphasis input pin.
16	PE2	DFS1	I	B	HZ	L	—	P. UP	Emphasis input pin.
17	PE3	MD RESET	O	B	HZ	H	L	P. UP	Reset signal output pin for MD Mecha.
18	VSS	—	—	—	—	—	—	—	GND connection. (GND for system)
19	PE4	MD ON	O	B	HZ	L	—	P. UP	Power ON/OFF switching signal output pin for MD Mecha.
20	PE5	LOAD IN	I	B	HZ	L	H	P. UP	Disc loading state signal input. (Disc loaded : H)
21	PE6	P. DOWN	O	B	HZ	H	L	P. UP	Back-up process direct pin.
22	PE7	O/C OUT	O	B	HZ	L	—	P. UP	Optical/Coaxial input switching output pin. (OPT-1: L, COAX: H)
23	PD0	OPT 1/2	O	B	HZ	L	—	P. UP	Optical input 1/2 switching output pin. (OPT-1: H, OPT-2: L)
24	PD1	D. OUT	O	B	HZ	H	—	P. UP	D. OUT MUTE signal output pin. (H : ON)
25	PD2	B.S.S	O	B	HZ	L	—	P. UP	Back-up volt detect ON/OFF signal output pin. (H : +3V, L : None)
26	PD3	3V ON/OFF	O	B	HZ	L	H	P. UP	3V ON/OFF switching signal output pin. (H : +3V, L : None)
27	PD4	TV/5V OUT	O	B	HZ	L	—	—	MD Mecha power voltage switching output pin.
28	PD5	NC	O	B	HZ	L	—	—	OPEN Not used.
29	PD6	NC	O	B	HZ	L	—	—	OPEN Not used.
30	PD7	NC	O	B	HZ	L	—	—	OPEN Not used.
31	VSS	—	—	—	—	—	—	—	GND connection. (GND for system)
32	PC0	LOCK	I	B	HZ	L	H	P. UP	Digital clock state detect signal input pin.
33	PC1	MU	I	B	HZ	L	H	P. UP	Mute signal input pin.
34	PC2	CTG1	O	B	HZ	—	—	P. UP	Data output pin for digital signal encode.
35	PC3	CTG2	O	B	HZ	L	H	P. UP	Clock output pin for digital signal encode.
36	PC4	CTG3	O	B	HZ	L	H	P. UP	Latch enable output pin for digital signal encode.
37	PC5	LBIT	O	B	HZ	L	H	P. UP	Copyright data output pin.
38	PC6	MLEN	O	B	HZ	—	—	P. UP	Latch enable output pin for SMS845 mode switching.
39	PC7	MCLK	O	B	HZ	—	—	P. UP	Clock output pin for SMS845 mode switching.
40	Vcc	—	—	—	—	—	—	—	+5V connection. (Power for system)
41	PB0	MDATA	O	B	HZ	—	—	P. UP	Data output pin for SMS845 mode switching.

Pin No.	Name	Symbol	I/O	Typ	Rst	Ini	Act	Ext	Function
42	PB1	EMPHA OUT	O	B	HZ	L	H	P. UP	Emphasis switching signal output pin.
43	PB2	ADRST	O	B	HZ	L	H	P. UP	Reset signal output pin for A/D · D/F.
44	PB3	AMUTE	O	B	HZ	L	H	P. UP	Mute signal output pin.
45	PB4	NC	O	B	HZ	L	—	—	OPEN Not used.
46	PB5	NC	O	B	HZ	L	—	—	OPEN Not used.
47	PB6	NC	O	B	HZ	L	—	—	OPEN Not used.
48	PB7	NC	O	B	HZ	L	—	—	OPEN Not used.
49	VSS	—	—	—	—	—	—	—	GND connection. (GND for system)
50	PA0	OP1	I	B	HZ	—	—	—	Character switching input pin.
51	PA1	OP2	I	B	HZ	—	—	—	Model switching input pin.
52	PA1	SERVICE	I	B	HZ	—	—	—	Service mode setting pin. (L : Service mode)
53	PA3	NC	O	B	HZ	L	—	—	Not used.
54	P50/TXD2	FLDA	O	B	HZ	H	—	P. UP	Data output pin for controlling FL display.
55	P51/RXD2	FLCS	O	B	HZ	H	L	P. UP	Chip select output pin for controlling FL display.
56	P52/SCK2	FLOK	O	B	HZ	H	—	P. UP	Clock output pin for controlling FL display.
57	MD0	MDO	I	A	HZ	L	H	P. UP	+5V connection.
58	MD1	MD1	I	A	HZ	L	H	P. UP	+5V connection.
59	P53	NC	O	B	HZ	L	—	—	OPEN Not used.
60	WDTOVF	WDTOVF	O	B	HZ	H	L	—	OPEN Not used.
61	MD2	MD2	I	A	HZ	L	H	P. UP	+5V connection.
62	RES	RESET	I	A	HZ	H	L	—	Reset signal input pin.
63	NMI	NMI	I	A	HZ	—	—	P. UP	+5V connection.
64	STBY	STBY	I	A	HZ	—	—	P. UP	+5V connection.
65	Vcc	—	—	—	—	—	—	—	+5V connection. (Power for system)
66	XTAL	OSC1	I	A	—	—	—	—	Ceramic oscillator pin.
67	EXTAL	OSC2	I	A	—	—	—	—	Ceramic oscillator pin.
68	VSS	—	—	—	—	—	—	—	GND connection. (GND for system)
69	PF7/φ	NC	O	B	HZ	L	—	—	OPEN Not used.
70	PF6	NC	O	B	HZ	L	—	—	OPEN Not used.
71	PF5	NC	O	B	HZ	L	—	—	OPEN Not used.
72	PF4	JOGB	I	B	HZ	—	—	P. UP	Jog B terminal pulse input pin.
73	PF3/IRQ3	JOGA	I	A	HZ	—	—	P. UP	Jog A terminal pulse input pin.
74	PF2/IRQ2	P. IN	I	A	HZ	—	↑	P. UP	Power watch signal input pin. (H : P. ON, L : P. OFF).
75	PF1/IRQ1	REMOTE	I	A	HZ	—	↑	P. UP	Remote control signal input pin.
76	PF0/IRQ0	NC	O	B	—	—	—	—	OPEN Not used.
77	AVcc	AVcc	—	—	—	—	—	—	+5V connection. (Power for system)
78	Vref	VREF	—	—	—	—	—	—	+5V connection. (Power for system)
79	P40/ANO	KEY0	I	B	HZ	—	—	P. UP	Key input signal pin.
80	P41/ANI	KEY1	I	B	HZ	—	—	P. UP	Key input signal pin.
81	P42/AN2	ATT LEVEL	I	B	HZ	—	—	P. UP	Input pin for digital ATT control.
82	P43/AN3	P. LEVEL	I	B	HZ	—	—	P. UP	+3V signal input pin.
83	AVSS	AVSS	—	—	—	—	—	—	GND connection. (GND for system)
84	VSS	—	—	—	—	—	—	—	GND connection. (GND for system)
85	P20	NC	O	B	HZ	L	—	—	OPEN Not used.
86	P21	NC	O	B	HZ	L	—	—	OPEN Not used.
87	P22/TMR10	NC	O	B	HZ	L	—	—	OPEN Not used.
88	P23/TMC10	NC	O	B	HZ	L	—	—	OPEN Not used.
89	P24/TMR11	NC	O	B	HZ	L	—	—	OPEN Not used.
90	P25/TMC11	NC	O	B	HZ	L	—	—	OPEN Not used.
91	P26/TMO0	NC	O	B	HZ	L	—	—	OPEN Not used.
92	P27/TMO1	NC	O	B	HZ	L	—	—	OPEN Not used.
93	PG0/ADTRG/IRQ6	JOGA	I	A	HZ	—	—	P. UP	Jog A terminal pulse inversion input pin.
94	PG1/IRQ7	NC	O	B	HZ	L	—	—	OPEN Not used.
95	PG2	NC	O	B	HZ	L	—	—	OPEN Not used.
96	PG3	NC	O	B	HZ	L	—	—	OPEN Not used.
97	PG4	NC	O	B	HZ	L	—	—	OPEN Not used.
98	Vcc	—	—	—	—	—	—	—	+5V connection. (Power for system)
99	P10/TIOCA0	TMREC	I	B	HZ	—	—	P. UP	Timer REC input pin.
100	P11/TIOCB0	TMPLY	I	B	HZ	—	—	P. UP	Timer PLAY input pin.

TYPE
A: Standard Input Port
B: Standard Output Port

AK5351 (IC503)

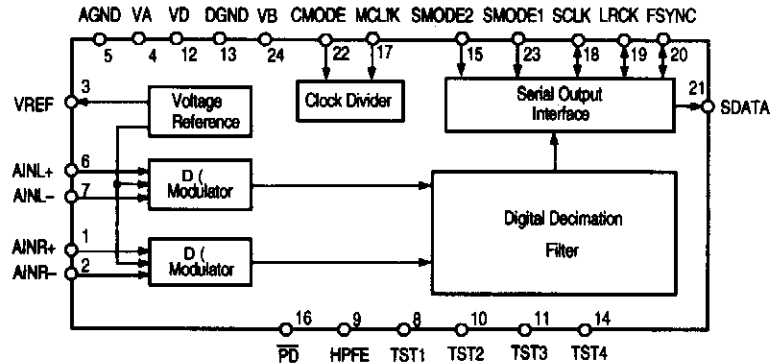
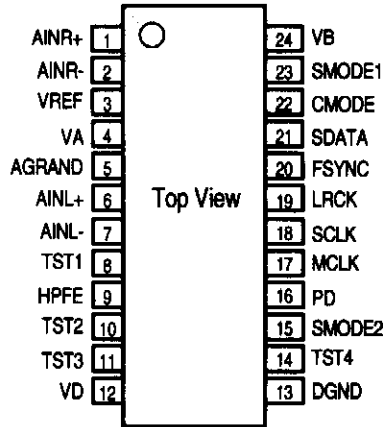

AK5351 Terminal Function

Pin No.	Name	I/O	Function
1	AINR+	I	Rch analog non-inverted input pin.
2	AINR-	I	Rch analog inverted input pin.
3	VREF	O	Ref. voltage output pin (VA=2.6V) Normally 0.1μF ceramic capacitor in parallel with 10μF electrolytic capacitor connected to VA.
4	VA	—	Analog part power pin (+5V).
5	AGND	—	Analog part ground pin.
6	AINL+	I	Lch analog non-inverted input pin.
7	AINL-	I	Lch analog inverted input pin.
8	TST1		Test pin, leave it open.
9	HPFE	I	Hi-pass filter enable pin. "H" : HI-pass filter ON, "L" : OFF).
10	TST2		Test pin, leave it open.
11	TST3		Test pin, leave it open.
12	VD	—	Digital part power pin (+5V).
13	DGND	—	Digital part ground pin.
14	TST4		Test pin, leave it open.
15	SMODE2	I	Interface clock select pin.
16	PD	I	Power down pin, "L" : Power down mode. Set to "L" once when power ON.
17	MCLK	I	Master clock input pin CMODE="H":384fs, "L":256fs
18	SCLK	I/O	Serial data clock pin.
19	LRCK	I/O	Input channel select pin.
20	FSYNC	I/O	Frame synchro clock pin.
21	SDATA	O	Serial data output pin.
22	CMODE	I	Master clock select pin "L":MCLK=256fs, "H":MCLK=384fs
23	SMODE1	I	Interface clock select pin.
24	VB	—	Bulk Power pin (+5V).

M66004FP (IC601)

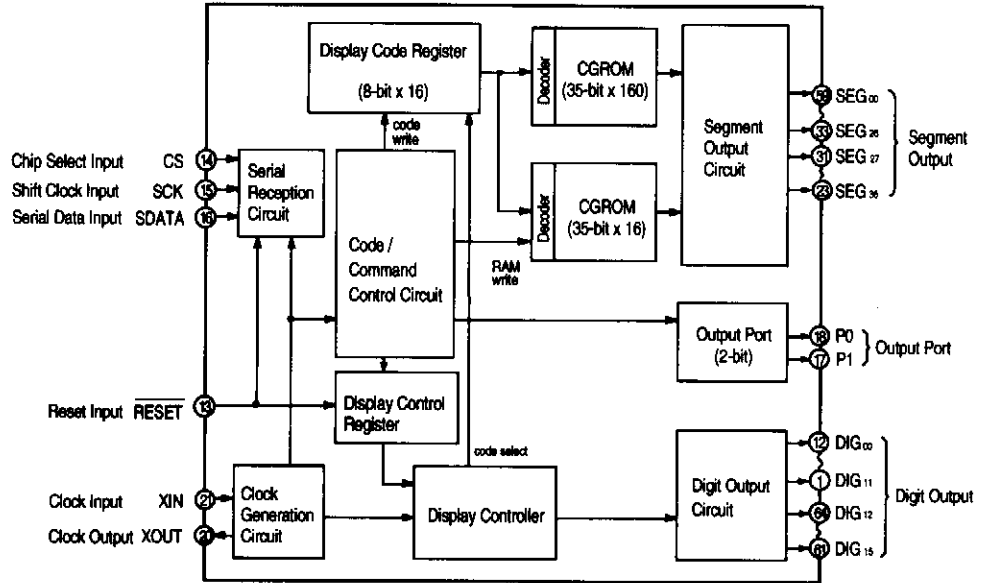
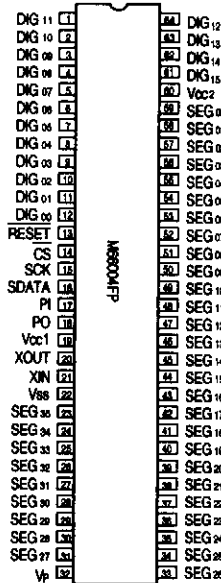
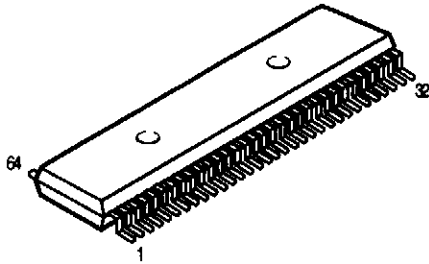

M66004FP Terminal Function

Symbol	Name	Function
RESET	Reset Input	Initializes internal state of M66004.
CS	Chip Select Input	Able to communicate with MCU in "L" mode. Command from MCU will be disregarded in "H" mode.
SCK	Shift Clock Input	Shifts input data at rise from "L" to "H".
SDATA	Serial Data Input	Inputs character code or command data needed to display from MSB.
XIN	Clock Input	Sets oscillation frequency by connecting external resistor and capacitor (maximum oscillation frequency fosc (max)=1MHz). Also feasible to apply external clock. In this case, inject external clock to Xin terminal and open Xout terminal.
XOUT	Clock Output	
DIG 00 ~ DIG15	Digit Output	Connect to digit terminal of VFD. DIG00~DIG15 correspond to the 1st figure to 16th figure respectively.
DIG 00 ~ DIG35	Segment Output	Connect to segment terminal of VFD. For corresponding SEG00~SEG35 to segment terminal of VFD, refer to the figure right.
P0, P1		Output port (static operation).
Vcc1		Positive power supply terminal for internal logic.
Vcc2		Positive power supply terminal for high tension output port.
Vss		GND terminal.
Vp		Negative power supply terminal for VFD drive.

00	01	02	03	04
05	06	07	08	09
10	11	12	13	14
15	16	17	18	19
20	21	22	23	24
25	26	27	28	29
30	31	32	33	34

35

(Forwarding connection of segment output terminal.)

□ in the right figure indicates 1 dot of segment, the figure in □ shows the segment output terminal number (00 ~ 35) to be connected.

BA17809T (IC104)
BA17805T (IC102)
NJM7805FA (IC105)

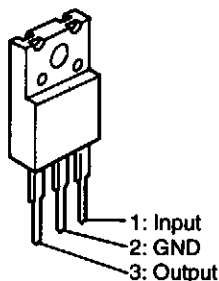

M5231TL
(IC103, 104)

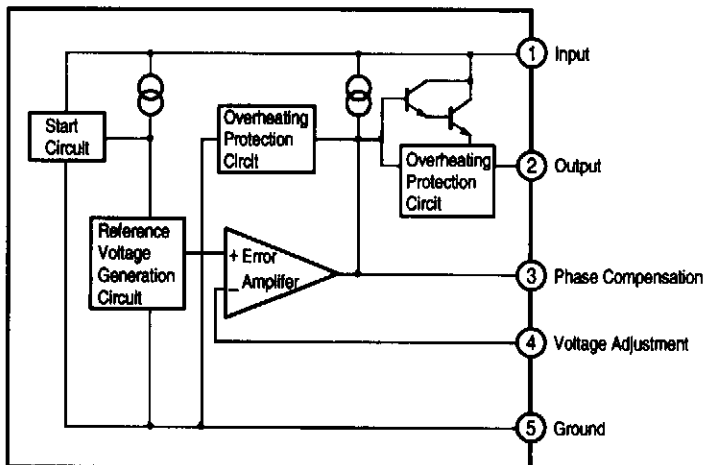
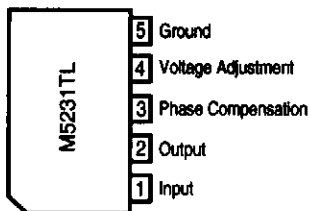

NJM7905FA
(IC106)

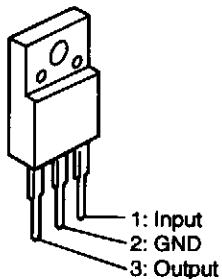

M5193A
(IC202)

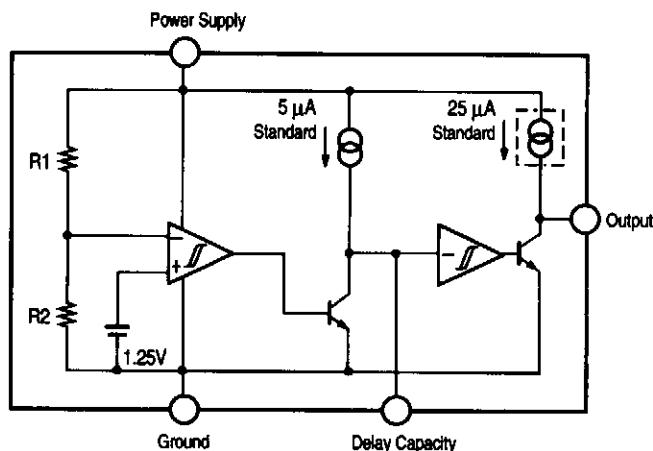
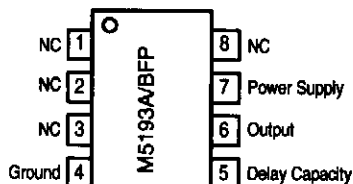

TC74HCT04AF (IC203)
TC74HCU04AF
(IC105, 107, 301, 403, 404)
TC74HC05AF (IC204)
TC74HC00AF (IC302, 303)

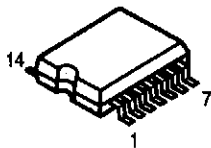

TC74HCT04AF
TC74HCU04AF

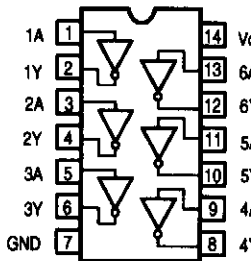

TC74HC00AF

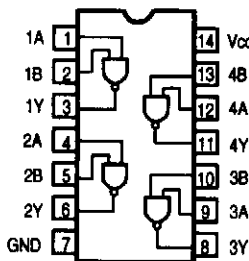

TC74HCU05AF

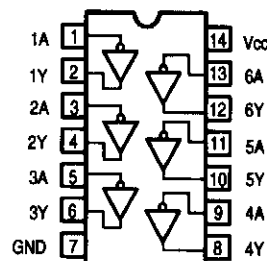

BA15218 (IC411, 504)

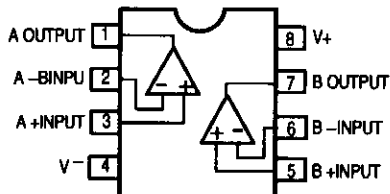
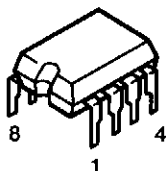

SM5841HS (IC406)

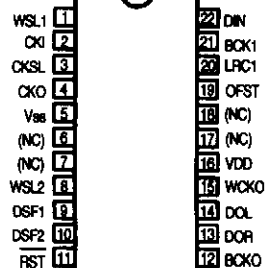
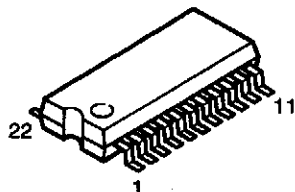

PCM61P-L (IC407, 408)

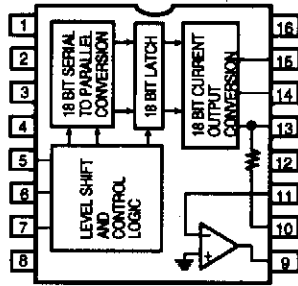
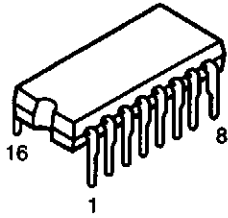

BA4510F (IC501, 502)
BA15218 (IC504)

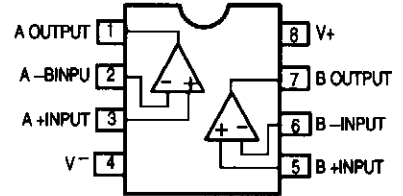
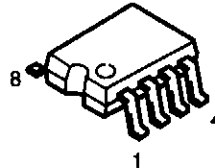

● TRANSISTOR

2SC1740S
2SD2144STPU

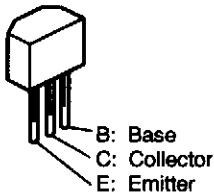

2SB562 (C)
2SD468 (C)

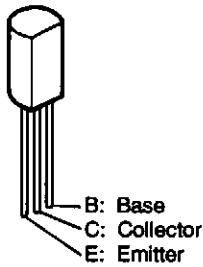

2SB1185 (E/F)
2SD1762 (E/F)

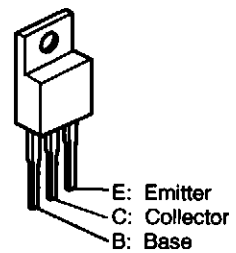

DTA124XKA
DTC114EK
DTC124EK
DTC323TK

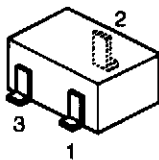

1: Emitter
2: Collector
3: Base

DTC323TK

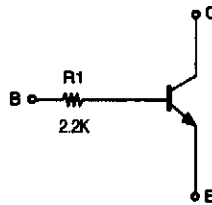

DTA124XKA

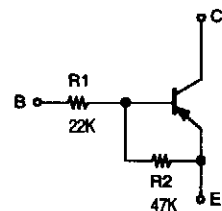

DTC114EK

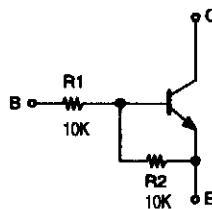

DTC124EK

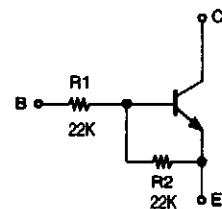

● DIODES

1SR35-200A

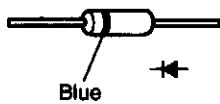

MTZJ6.2A
MTZJ8.2A
MTZJ39A

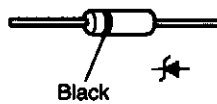

1SS270A

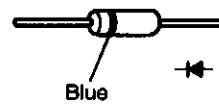

● FL DISPLAY (FL601)
(Part No. 393 4157 000)

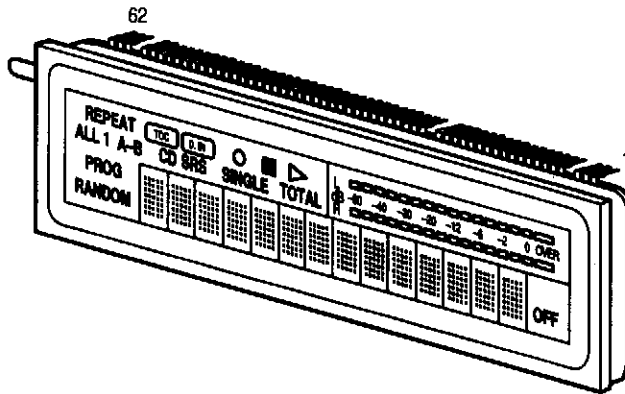

Grid Partition

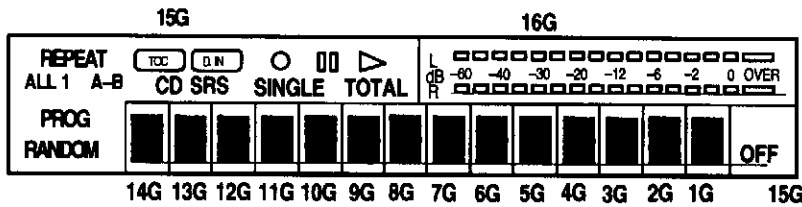

1	2	3	4	5
6	7	8	9	10
11	12	13	14	15
16	17	18	19	20
21	22	23	24	25
26	27	28	29	30
31	32	33	34	35

Pin Connection

Pin No.	21	20	19	18	17	16	15	14	13	12	11	10	9	8	7	6	5	4	3	2	1
Electrode	16G	15G	14G	13G	12G	11G	10G	9G	8G	7G	6G	5G	4G	3G	2G	1G	NC	NP	NP	F1	F1

Pin No.	42	41	40	39	38	37	36	35	34	33	32	31	30	29	28	27	26	25	24	23	22
Electrode	P20	P19	P18	P17	P16	P15	P14	P13	P12	P11	P10	P9	P8	P7	P6	P5	P4	P3	P2	P1	NC

Pin No.	62	61	60	59	58	57	56	55	54	53	52	51	50	49	48	47	46	45	44	43
Electrode	F2	F2	NP	NP	NC	P35	P34	P33	P32	P31	P30	P29	P28	P27	P26	P25	P24	P23	P22	P21

- Note
- 1) F1, F2 ----- Filament
 - 2) NP ----- No pin
 - 3) NC ----- No connection
 - 4) P1~P35 ----- Anode
 - 5) 1G~16G ----- Grid

Internal Connection

	1~14G	15G	18G
P1	1	TOTAL	1
P2	2	⊙	2
P3	3	SINGLE	3
P4	4	⏏	4
P5	5	○	5
P6	6	CD SRS	6
P7	7	D IN	7
P8	8	TOC	8
P9	9	B	9
P10	10	A-	10
P11	11	1	11
P12	12	REPEAT	12

	1~14G	15G	18G
P13	13	ALL	13
P14	14	RANDOM	14
P15	15		15
P16	16		16
P17			
P18	18		18
P19	19		19
P20	20		20
P21	21		21
P22	22		22
P23	23		23
P24	24		24

	1~14G	15G	18G
P25	25	ALL	25
P26	26	RANDOM	26
P27	27		27
P28	28		28
P29	29		29
P30	30		30
P31	31		31
P32	32		32
P33	33		33
P34	34		34
P35	35	OFF	

PRINTED WIRING BOARD PATTERNS

1

2

3

4

1U-3074 POWER UNIT ASS'Y

A

B

C

D

E

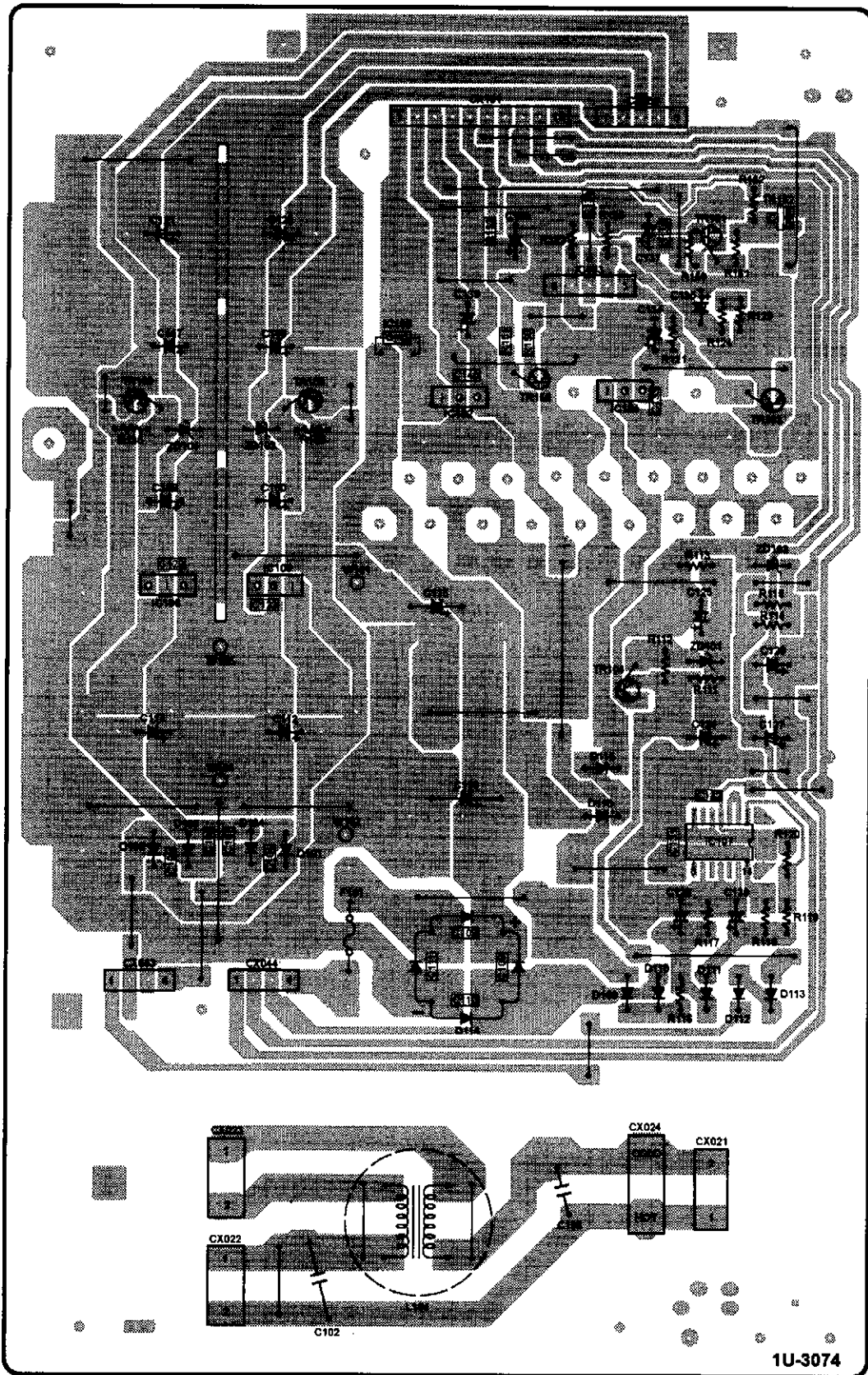

1U-3074

1U-3073 MAIN UNIT ASS'y

1 2 3 4 5 6 7 8

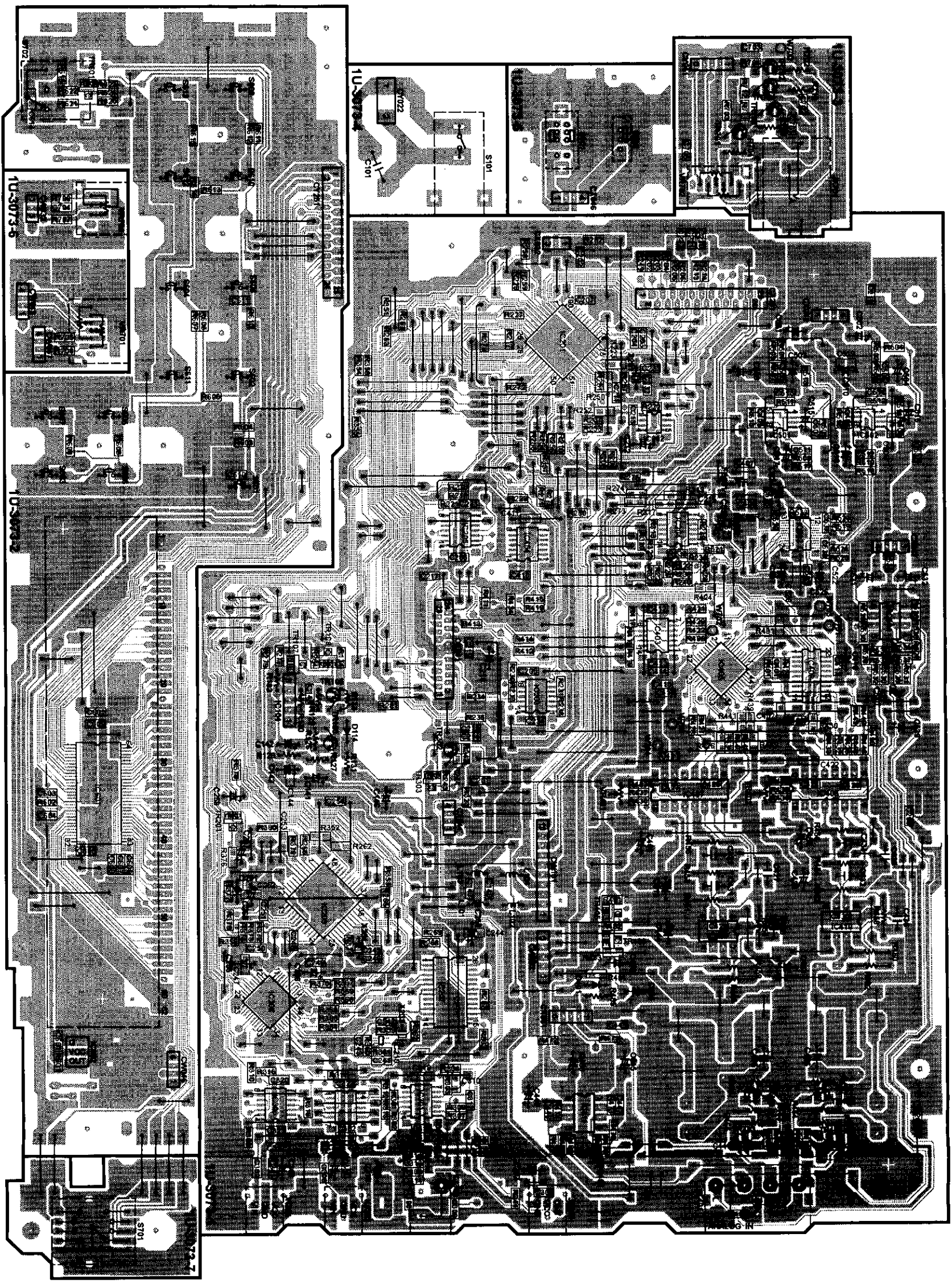

A B C D E

NOTE FOR PARTS LIST

● Part indicated with the mark "⊙" are not always in stock and possibly to take a long period of time for supplying, or in some case supplying of part may be refused.
 ● When ordering of part, clearly indicate "1" and "1" (1) to avoid mis-supplying.
 ● Ordering part without stating its part number can not be supplied.
 ● Part indicated with the mark "★" is not illustrated in the exploded view.
 ● Not including Carbon Film ±5%, 1/4W Type in the P.W.Board parts list. (Refer to the Schematic Diagram for those parts.)

WARNING:
 Parts marked with this symbol **Δ** have critical characteristics.
 Use ONLY replacement parts recommended by the manufacturer.

● Resistors

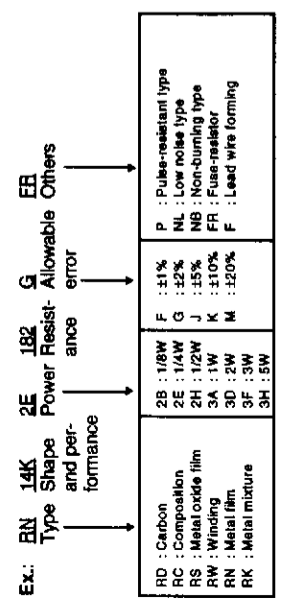

● Capacitors

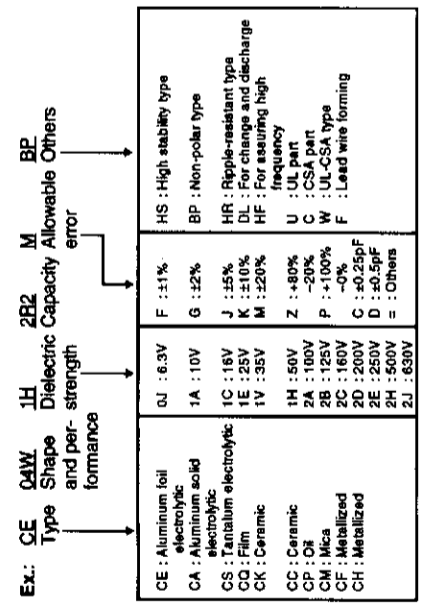

PARTS LIST OF P.W.B. UNIT ASSY 1U-3073 MAIN UNIT ASSY

Ref. No.	Part No.	Part Name	Remarks
SEMICONDUCTORS GROUP			
IC104	263 1041 009	IC M5231TL	
IC201	262 2430 001	IC HD6432245F10	
IC202	263 0530 906	IC M51953A	
IC203	262 1421 901	IC TC74HC04AF	
IC205	262 1205 907	IC TC74HC04AF	
IC301	262 1205 907	IC TC74HC04AF	
IC302,303	262 1719 902	IC TC74HC00AF	
IC403,404	262 1205 907	IC TC74HC04AF	
IC406	262 2210 904	IC SM5841HS	
IC407,408	262 1409 004	IC PCM61-L	
IC411	263 0565 007	IC BA15218	
IC501,502	263 0934 900	IC BA4510F	
IC503	262 2426 905	IC AK5351-VF	
IC504	263 0565 007	IC BA15218	
IC601	262 1954 902	IC M66004FP	
IC602	499 0290 007	IC GP1U271X	
TR105	272 0025 907	Transistor 2SB562(C)	
TR106	273 0303 910	Transistor 2SC1740S(S)	
TR107	269 0082 902	Transistor DTC114EK	
TR108	269 0054 901	Transistor DTC144EK	
TR301	269 0066 902	Transistor DTC323TK	
TR302	272 0025 907	Transistor 2SB562(C)	
TR303	269 0082 902	Transistor DTC114EK	
TR401-404	274 0160 907	Transistor 2SD144STPU	
TR405	269 0156 906	Transistor DTA124XKA	
TR406	269 0082 902	Transistor DTC114EK	
TR601	269 0102 905	Transistor DTC124EK	
TR701,702	274 0160 907	Transistor 2SD144STPU	
D114	276 0432 903	Diode 1SS270A	
D301,302	276 0432 903	Diode 1SS270A	
D401	276 0432 903	Diode 1SS270A	
FL601	393 4157 000	FLD BJ588GK	
RESISTORS GROUP			
R131	244 2050 904	Metal oxide 22ohm 1W	RS14B3A220JNBS(S)
R134	247 0009 985	Carbon chip 10kohm 1/10W	RM73B--103J
R202-206	247 0011 944	Carbon chip 47kohm 1/10W	RM73B--473J
R207	247 0009 985	Carbon chip 10kohm 1/10W	RM73B--103J
R213,214	247 0011 944	Carbon chip 47kohm 1/10W	RM73B--473J
R222	247 0007 945	Carbon chip 1kohm 1/10W	RM73B--102J
R223	247 0005 976	Carbon chip 200ohm 1/10W	RM73B--201J
R227	247 0012 927	Carbon chip 100kohm 1/10W	RM73B--104J
R230,231	247 0018 905	Carbon chip 10ohm 1/10W	RM73B--0R0K
R234,235	247 0018 905	Carbon chip 10ohm 1/10W	RM73B--0R0K
R238,239	247 0018 905	Carbon chip 10ohm 1/10W	RM73B--0R0K
R240,241	247 0018 905	Carbon chip 10ohm 1/10W	RM73B--0R0K
R242	247 0012 927	Carbon chip 100kohm 1/10W	RM73B--104J
R243	247 0008 915	Carbon chip 2kohm 1/10W	RM73B--202J
R244	247 0007 945	Carbon chip 1kohm 1/10W	RM73B--102J
R249	247 0011 944	Carbon chip 47kohm 1/10W	RM73B--473J
R250-253	247 0009 985	Carbon chip 10kohm 1/10W	RM73B--103J
R258	247 0012 927	Carbon chip 100kohm 1/10W	RM73B--104J
R261	247 0012 927	Carbon chip 100kohm 1/10W	RM73B--104J
R263,264	247 0012 927	Carbon chip 100kohm 1/10W	RM73B--104J
R266	247 0011 944	Carbon chip 47kohm 1/10W	RM73B--473J
R275	247 0012 927	Carbon chip 100kohm 1/10W	RM73B--104J
R276	247 0011 944	Carbon chip 47kohm 1/10W	RM73B--473J
R277	247 0012 927	Carbon chip 100kohm 1/10W	RM73B--104J
R279	247 0009 985	Carbon chip 10kohm 1/10W	RM73B--103J
R280,281	247 0012 927	Carbon chip 100kohm 1/10W	RM73B--104J
R301-303	247 0011 944	Carbon chip 47kohm 1/10W	RM73B--473J
R304	247 0005 905	Carbon chip 100ohm 1/10W	RM73B--101J
R305	247 0018 905	Carbon chip 10ohm 1/10W	RM73B--0R0K
R306	247 0004 977	Carbon chip 75ohm 1/10W	RM73B--750J
R307	247 0011 944	Carbon chip 47kohm 1/10W	RM73B--473J
R308	247 0013 942	Carbon chip 330kohm 1/10W	RM73B--334J
R310	247 0005 905	Carbon chip 100ohm 1/10W	RM73B--101J
R312,313	247 0018 905	Carbon chip 10ohm 1/10W	RM73B--0R0K
R314	247 0008 915	Carbon chip 2kohm 1/10W	RM73B--202J
R315,316	247 0018 905	Carbon chip 10ohm 1/10W	RM73B--0R0K
R323	247 0018 905	Carbon chip 10ohm 1/10W	RM73B--0R0K
R357,358	247 0011 944	Carbon chip 47kohm 1/10W	RM73B--473J
R401	247 0018 905	Carbon chip 10ohm 1/10W	RM73B--0R0K
R411	257 0011 909	Ceramic chip 0.01µF25V	CK73B1E103K
R412	247 0018 905	Carbon chip 10ohm 1/10W	RM73B--0R0K
R413	257 0011 909	Ceramic chip 0.01µF25V	CK73B1E103K
R414	247 0018 905	Carbon chip 10ohm 1/10W	RM73B--0R0K
R415	247 0011 944	Carbon chip 47kohm 1/10W	RM73B--473J
R417	247 0011 944	Carbon chip 47kohm 1/10W	RM73B--473J
R419	247 0018 905	Carbon chip 10ohm 1/10W	RM73B--0R0K
R420-424	247 0007 945	Carbon chip 1kohm 1/10W	RM73B--102J
R429	247 0018 905	Carbon chip 10ohm 1/10W	RM73B--0R0K

Ref. No.	Part No.	Part Name	Remarks
R430-433	247 0006 920	Carbon chip 330ohm 1/10W	RM73B--331J
R434	247 0013 942	Carbon chip 330kohm 1/10W	RM73B--334J
R435,436	247 0013 984	Carbon chip 470kohm 1/10W	RM73B--474J
R437,438	247 0014 967	Carbon chip 1Mohm 1/10W	RM73B--105J
R467-470	247 0008 944	Carbon chip 2.7kohm 1/10W	RM73B--272J
R471,472	247 0018 905	Carbon chip 0ohm 1/10W	RM73B--0R0K
R473,474	247 0011 957	Carbon chip 51kohm 1/10W	RM73B--513J
R475,476	247 0008 986	Carbon chip 3.9kohm 1/10W	RM73B--392J
R477,478	247 0008 999	Carbon chip 4.3kohm 1/10W	RM73B--432J
R479,480	247 0010 990	Carbon chip 30kohm 1/10W	RM73B--303J
R481	247 0018 905	Carbon chip 0ohm 1/10W	RM73B--0R0K
R482	247 0012 998	Carbon chip 200kohm 1/10W	RM73B--204J
R483	247 0018 905	Carbon chip 0ohm 1/10W	RM73B--0R0K
R484	247 0004 922	Carbon chip 47ohm 1/10W	RM73B--470J
R485	244 2051 974	Metal oxide 1kohm 1W	RS14B3A102JNBS(S)
R487,488	247 0012 998	Carbon chip 200kohm 1/10W	RM73B--204J
R491	247 0018 905	Carbon chip 0ohm 1/10W	RM73B--0R0K
R503,504	247 0009 985	Carbon chip 10kohm 1/10W	RM73B--103J
R505,506	247 0011 915	Carbon chip 36kohm 1/10W	RM73B--363J
R507-510	247 0009 901	Carbon chip 4.7kohm 1/10W	RM73B--472J
R511,512	247 0010 958	Carbon chip 20kohm 1/10W	RM73B--203J
R515,516	247 0010 958	Carbon chip 20kohm 1/10W	RM73B--203J
R519,520	247 0006 920	Carbon chip 330ohm 1/10W	RM73B--331J
R521	247 0006 962	Carbon chip 470ohm 1/10W	RM73B--471J
R523,524	247 0006 920	Carbon chip 330ohm 1/10W	RM73B--331J
R525,526	247 0018 905	Carbon chip 0ohm 1/10W	RM73B--0R0K
R527,528	247 0010 945	Carbon chip 18kohm 1/10W	RM73B--183J
R531,532	247 0006 962	Carbon chip 470ohm 1/10W	RM73B--471J
R537,538	247 0011 944	Carbon chip 47kohm 1/10W	RM73B--473J
R539	247 0018 905	Carbon chip 0ohm 1/10W	RM73B--0R0K
R601	247 0009 985	Carbon chip 10kohm 1/10W	RM73B--103J
R602	247 0010 987	Carbon chip 27kohm 1/10W	RM73B--273J
R603	247 0007 945	Carbon chip 1kohm 1/10W	RM73B--102J
R604	247 0005 947	Carbon chip 150ohm 1/10W	RM73B--151J
R605	247 0005 963	Carbon chip 180ohm 1/10W	RM73B--181J
R606	247 0006 904	Carbon chip 270ohm 1/10W	RM73B--271J
R607	247 0006 946	Carbon chip 390ohm 1/10W	RM73B--391J
R608	247 0006 975	Carbon chip 510ohm 1/10W	RM73B--511J
R609	247 0007 932	Carbon chip 910ohm 1/10W	RM73B--911J
R610	247 0007 945	Carbon chip 1kohm 1/10W	RM73B--102J
R611	247 0005 947	Carbon chip 150ohm 1/10W	RM73B--151J
R612	247 0005 963	Carbon chip 180ohm 1/10W	RM73B--181J
R613	247 0006 904	Carbon chip 270ohm 1/10W	RM73B--271J
R614	247 0006 946	Carbon chip 390ohm 1/10W	RM73B--391J
R615	247 0006 975	Carbon chip 510ohm 1/10W	RM73B--511J
R621,622	247 0005 905	Carbon chip 100ohm 1/10W	RM73B--101J
R623-625	247 0009 985	Carbon chip 10kohm 1/10W	RM73B--103J
R701,702	244 2055 970	Metal oxide 56ohm 1W	RS14B3A560JNBS(S)
R703,704	247 0008 944	Carbon chip 2.7kohm 1/10W	RM73B--272J

Ref. No.	Part No.	Part Name	Remarks
R705,706	247 0018 905	Carbon chip 0ohm 1/10W	RM73B--0R0K
VR401,402	211 6093 970	Semi fixed resistor 100kohm	V06PB104T
VR701	211 0876 009	Variable resistor 50kohm	V1420V16FA503
VR702	211 0903 008	Variable resistor 2kohm	V1420Q15FC202
CAPACITORS GROUP			
C101	253 8014 702	Ceramic 0.01μF/400V(AC)	CK45F2GAC103MC
C141,142	254 4260 948	Electrolytic 1μF/50V	CE04W1H010M
C143	254 4254 909	Electrolytic 10μF/16V	CE04W1C100M
C144	257 0010 900	Ceramic chip 0.01μF/50V	CK73B1H103K
C146	259 0009 001	Back up cap. 1F/6.3V	GOLD CAP=105=
C201	257 0012 966	Ceramic chip 0.01μF/50V	CK73F1H103Z
C202	257 0010 900	Ceramic chip 0.01μF/50V	CK73B1H103K
C205,206	257 0012 966	Ceramic chip 0.01μF/50V	CK73F1H103Z
C207	257 0010 900	Ceramic chip 0.01μF/50V	CK73B1H103K
C211	257 0010 900	Ceramic chip 0.01μF/50V	CK73B1H103K
C212	254 4260 948	Electrolytic 1μF/50V	CE04W1H010M
C213	257 0010 900	Ceramic chip 0.01μF/50V	CK73B1H103K
C214-217	257 0012 966	Ceramic chip 0.01μF/50V	CK73F1H103Z
C220-222	257 0012 966	Ceramic chip 0.01μF/50V	CK73F1H103Z
C233,234	257 0012 966	Ceramic chip 0.01 F/50V	CK73F1H103Z
C301,302	257 0010 900	Ceramic chip 0.01μF/50V	CK73B1H103K
C303	254 4254 941	Electrolytic 100μF/16V	CE04W1C101M
C304	257 0010 900	Ceramic chip 0.01μF/50V	CK73B1H103K
C305	254 4254 941	Electrolytic 100μF/16V	CE04W1C101M
C306	257 0010 900	Ceramic chip 0.01μF/50V	CK73B1H103K
C307	254 4254 941	Electrolytic 100μF/16V	CE04W1C101M
C308	257 0010 900	Ceramic chip 0.01μF/50V	CK73B1H103K
C310	257 0010 900	Ceramic chip 0.01μF/50V	CK73B1H103K
C311,312	257 0014 935	Ceramic chip 0.1μF/25V	CK73F1E104Z
C313	257 0012 966	Ceramic chip 0.01μF/50V	CK73F1H103Z
C314	257 0003 988	Ceramic chip 47pF/50V	CC73SL1H470J
C315	257 0010 900	Ceramic chip 0.01μF/50V	CK73B1H103K
C316	254 4260 948	Electrolytic 1μF/50V	CE04W1H010M
C317	257 0005 902	Ceramic chip 150pF/50V	CC73SL1H151J
C318-320	257 0012 966	Ceramic chip 0.01μF/50V	CK73F1H103Z
C322,323	257 0012 966	Ceramic chip 0.01μF/50V	CK73F1H103Z
C405,406	257 0002 921	Ceramic chip 10 pF/50V	CC73SL1H100D
C409	257 0012 966	Ceramic chip 0.01μF/50V	CK73F1H103Z
C410-413	257 0010 900	Ceramic chip 0.01μF/50V	CK73B1H103K
C417	257 0014 935	Ceramic chip 0.1μF/25V	CK73F1E104Z
C418	254 4254 941	Electrolytic 100μF/16V	CE04W1C101M
C419	254 4356 713	Electrolytic 100μF/50V	CE04W1H010MC(ARS)
C421,422	257 0014 935	Ceramic chip 0.1μF/25V	CK73F1E104Z
C425,426	257 0014 935	Ceramic chip 0.1μF/25V	CK73F1E104Z

Ref. No.	Part No.	Part Name	Remarks	Ref. No.	Part No.	Part Name	Remarks	Q'ty	
C427,428	255 4235 992	Polypropylene film 680pF/100V	CQ93P2A681J(NH)	OTHER PARTS GROUP					
C433,434	255 4235 963	Polypropylene film 5600pF/100V	CQ93P2A562J(NH)	CW042	203 6499 007	4P PH-SAN connector cord		1	
C445,446	254 4368 934	Electrolytic 100μF/25V	CE04W1E101M(ASF)	CW046	203 6236 040	4P KR-DA connector cord		1	
C447,448	257 0004 903	Ceramic chip 56pF/50V	CC73SL1H560J	CW047	203 6499 049	4P PH-SAN connector cord		1	
C449	257 0004 961	Ceramic chip 100pF/50V	CC73SL1H101J	CW052	203 8414 019	5P EH-SCN connector cord		1	
C450,451	254 4368 934	Electrolytic 100μF/25V	CE04W1E101M(ASF)	CW101	204 6608 008	10P EH-SCN connector cord		1	
C452	254 4256 952	Electrolytic 220μF/25V	CE04W1E221M	CX041	205 0343 045	4P connector base(KR-PH)		1	
C453	254 3056 917	Electrolytic 1μF/50V	CE04D1H010MBP	CX042	205 0321 041	4P connector base (RED)		1	
C456	254 4356 713	Electrolytic 100μF/50V	CE04W1H101MC(ARS)	CX046	205 0279 041	4P PH.SID connector base		1	
C465,466	254 4356 713	Electrolytic 100μF/50V	CE04W1H101MC(ARS)	CX047	205 0321 041	4P connector base (RED)		1	
C469,470	257 0012 966	Ceramic chip 0.01μF/50V	CK73F1H103Z	CX051	205 0343 058	5P connector base(KR-PH)		1	
C501,502	254 4313 921	Electrolytic 22μF/50V	CE04W1H220M(ASF)	CX241	205 0892 046	24P FFC base (P=1)		1	
C503,504	254 4382 910	Electrolytic 220μF/16V	CE04W1C221M(ASF)	CX251	205 0736 089	25P FFC connector base		1	
C505,506	257 0014 935	Ceramic chip 0.1μF/25V	CK73F1E104Z	CY022	205 0581 085	2P VH connector base		1	
C507,508	257 0002 921	Ceramic chip 10 pF/50V	CC73SL1H100D	CY051	205 0343 058	5P connector base(KR-PH)		1	
C513,514	257 0014 935	Ceramic chip 0.1μF/25V	CK73F1E104Z	CY251	205 0736 089	25P FFC connector base		1	
C515-518	254 4313 918	Electrolytic 10μF/50V	CE04W1H100M(ASF)	FB501,502	235 0049 900	Beads inductor		2	
C519	257 0012 966	Ceramic chip 0.01μF/50V	CK73F1H103Z	J501,503	235 0049 900	Beads inductor		2	
C520	257 0011 996	Ceramic chip 0.1μF/25V	CK73B1E104K	JK301,302	269 0172 003	GP1F37R		2	
C521	257 0009 966	Ceramic chip 4700pF/50V	CK73B1H472K	JK303	269 0098 006	GP1F32T (OPT. OUT)		1	
C522,523	257 0011 909	Ceramic chip 0.01μF/25V	CK73B1E103K	JK304	204 8178 028	1P pin jack		1	
C524	254 4313 918	Electrolytic 10μF/50V	CE04W1H100M(ASF)	JK401	204 8540 012	4P pin jack		1	
C525	257 0011 909	Ceramic chip 0.01μF/25V	CK73B1E103K	JK701	204 8322 007	Headphone jack		1	
C526,527	254 4356 797	Electrolytic 10μF/50V	CE04W1H100MC(ARS)	AS101	212 1101 006	Power switch (TV-5)		1	
C528	257 0011 909	Ceramic chip 0.01μF/25V	CK73B1E103K	S601-613	212 5604 910	Tact switch		13	
C531,532	254 4313 921	Electrolytic 22μF/50V	CE04W1H220M(ASF)	S701	212 0388 008	Rotary switch (1-5)		1	
C535	254 4382 910	Electrolytic 220μF/16V	CE04W1C221M(ASF)	S702	212 0382 004	Rotary encoder		1	
C537,538	257 0009 908	Ceramic chip 1500pF/50V	CK73B1H152K	S801	212 1046 006	Slide switch (2-3)		1	
C539,540	254 4368 934	Electrolytic 100μF/25V	CE04W1E101M(ASF)	S802	212 1048 004	Slide switch (1-2)		1	
C601	257 0010 900	Ceramic chip 0.01μF/50V	CK73B1H103K	W300	4123100003	PWB Earth		1	
C602,603	257 0012 966	Ceramic chip 0.01μF/50V	CK73F1H103Z	X201	3990160905	Crystal 8.00MHz		1	
C604	257 0004 961	Ceramic chip 100pF/50V	CC73SL1H101J		4610862016	FL spacer		2	
C605	257 0012 966	Ceramic chip 0.01μF/50V	CK73F1H103Z		2050452017	Style pin		2	
C606-608	257 0005 931	Ceramic chip 200pF/50V	CC73SL1H201J						
C609	257 0012 966	Ceramic chip 0.01μF/50V	CK73F1H103Z						
C610,611	257 0007 900	Ceramic chip 1000pF/50V	CC73SL1H102J						
C614,615	257 0010 900	Ceramic chip 0.01μF/50V	CK73B1H103K						
C701,702	257 0012 966	Ceramic chip 0.01μF/50V	CK73F1H103Z						
C705	257 0012 966	Ceramic chip 0.01μF/50V	CK73F1H103Z						

1U-3074 POWER UNIT ASS'Y

Ref. No.	Part No.	Part Name	Remarks
SEMICONDUCTORS GROUP			
IC102	263 1055 008	IC BA17805T	
IC103	263 1041 009	IC M5231TL	
IC104	263 1054 009	IC BA17809T	
IC105	263 0809 006	IC NJM7805FA(S)	
IC106	263 0554 005	IC NJM7905FA	
IC107	262 1205 907	IC TC74HCU04AF	
IC108	268 0073 905	IC ICP-N15	IC protector
TR103,104	272 0083 004	Transistor 2SB1185(E/F)	
TR108	272 0025 907	Transistor 2SB562(C)	
TR109	274 0036 905	Transistor 2SD468(D)	
TR150	273 0303 910	Transistor 2SC1740S(S)	
D101-104	276 0553 905	Diode 1SR35-200A	
D109-113	276 0553 905	Diode 1SR35-200A	
D114	276 0305 001	Diode S4VB20	
ZD101	276 0645 981	Zener diode MTZJ39A	39V
ZD102	276 0637 902	Zener diode MTZJ6.2A	6.2V
ZD103,104	276 0644 924	Zener diode MTZJ8.2A	8.2V
RESISTORS GROUP			
R117	244 2052 973	Metal oxide 560ohm 1W	RS14B3A561JNBS(S)
R122	245 2368 903	Metal film 3.3kohm 1/4W	RN14K2E332F(5)
R123	245 2368 961	Metal film 5.6kohm 1/4W	RN14K2E562F(5)
R150	247 0009 956	Carbon chip 7.5kohm 1/10W	RM73B--752J
R151	247 0007 945	Carbon chip 1kohm 1/10W	RM73B--102J
R152	247 0013 900	Carbon chip 220kohm 1/10W	RM73B--224J
CAPACITORS GROUP			
C104-111	257 0010 900	Ceramic chip 0.01μF/50V	CK73B1H103K
C112,113	254 4313 727	Electrolytic 2200μF/50V	CE04W1H222M(ASF)
C114	254 4403 747	Electrolytic 10000μF/25V	CE04W1E103M(SMG)
C115	254 4403 705	Electrolytic 6800μF/25V	CE04W1E682M(SMG)
C120,121	254 4356 713	Electrolytic 100μF/50V	CE04W1H101MC(ARS)
C122,123	255 4235 934	Polypropylene film 0.01μF/100V	CQ93P2A103J(NH)
C124	254 4262 946	Electrolytic 47μF/63V	CE04W1J470M
C125	254 4260 980	Electrolytic 10μF/50V	CE04W1H100M
C126	254 4299 906	Electrolytic 10μF/16V	CE04W1C100M(SRE)
C127,128	254 4261 905	Electrolytic 33μF/50V	CE04W1H330M
C130	254 4300 905	Electrolytic 33μF/6.3V	CE04W0J330M(SRE)
C131	257 0010 900	Ceramic chip 0.01μF/50V	CK73B1H103K
C132	257 0010 942	Ceramic chip 0.022μF/50V	CK73B1H223K
C133	257 0010 900	Ceramic chip 0.01μF/50V	CK73B1H103K
C134,135	254 4260 948	Electrolytic 1μF/50V	CE04W1H010M
C137	254 4254 954	Electrolytic 220μF/16V	CE04W1C221M
C138	257 0010 900	Ceramic chip 0.01μF/50V	CK73B1H103K
C139	254 4260 980	Electrolytic 10μF/50V	CE04W1H100M

Ref. No.	Part No.	Part Name	Remarks	Q'ty
C147,148	254 4382 910	Electrolytic 220μF/16V	CE04W1C221M(ASF)	
C149,150	254 4368 934	Electrolytic 100μF/25V	CE04W1E101M(ASF)	
C160	254 4260 948	Electrolytic 1μF/50V	CE04W1H010M	
OTHER PARTS GROUP				
CX021	205 0581 001	2P VH connector base		1
CX022	205 0581 085	2P VH connector base		1
CX023	205 0581 056	2P VH connector base		1
CX043	205 0277 043	4P EH connector base (RD)		1
CX044	205 0233 045	4P EH connector base		1
CX052	205 0233 058	5P EH connector base		1
CX101	205 0275 003	10P EH connector base		1
A F101	205 4313 001	Fuse 2A	Except U.S.A./ Canada models	
A F102	205 4313 002	Fuse 2.5A	U.S.A./ Canada models	
	202 0040 909	Fuse clip		2
	417 0476 049	Radiator		1
	417 0560 010	Heat sink(SE553)		1
	471 3304 015	Screw 3X8 CBS-Z		3
	205 0452 017	Style pin		3
	513 2585 032	Fuse label	Except U.S.A./ Canada model	1
	513 2492 057	Fuse label	U.S.A./ Canada models	1

MDM97 MD MECHANISM P.W.B. UNIT ASS'Y

Ref. No.	Part No.	Part Name	Remarks	Ref. No.	Part No.	Part Name	Remarks
SEMICONDUCTORS GROUP							
IC1101	937 0213 308	IC IR3R55		R1201		Carbom (Chip) 150ohm 1/16W	VRS-CY1JB151J
IC1201	937 0213 405	IC LR37648A		R1202		Carbom (Chip) 1Mohm 1/16W	VRS-CY1JB105J
IC1202	937 0177 800	IC IX2474AF		R1210		Carbom (Chip) 100ohm 1/16W	VRS-CY1JB101J
IC1251	937 0104 080	IC 74ACT02F		R1211		Carbom (Chip) 220ohm 1/16W	VRS-CY1JB221J
IC1401	937 0213 502	IC IX0197		R1221		Carbom (Chip) 220ohm 1/16W	VRS-CY1JB221J
IC1402	937 0206 205	IC S29294A		R1221		Carbom (Chip) 220ohm 1/16W	VRS-CY1JB221J
IC1601	937 0213 609	IC M56758FP		R1223		Carbom (Chip) 680ohm 1/10W	VRS-TY2AB681J
IC1801	937 0214 705	IC XC62EP32		R1251		Carbom (Chip) 10ohm 1/16W	VRS-CY1JB100J
IC1906	937 0142 903	IC TC7ST08F		R1252,1253	937 9955 201	Carbom (Chip) 0ohm	VRS-TV2AB000J
IC1907	937 0213 706	IC TC9246F		R1254	937 9956 103	Carbom (Chip) 220ohm 1/16W	VRS-TV2AB221J
IC1916	937 0213 803	IC 74VHC08FS		R1255		Carbom (Chip) 0ohm	VRS-TV2AB000J
IC1990	937 0104 064	IC 74C04FS		R1261-1263	937 9958 664	Carbom (Chip) 10kohm 1/16W	VRS-CY1JB100J
Q1251,1252	937 0104 200	Transistor 2SK2909		R1266	937 9958 664	Carbom (Chip) 10kohm 1/16W	VRS-CY1JB100J
Q1253,1254	937 0104 103	Transistor 2SK1473		R1269		Carbom (Chip) 0ohm	VRS-CY1JB000J
Q1401	937 0205 206	Transistor RN2402		R1281		Carbom (Chip) 47ohm 1/16W	VRS-CY1JB470J
Q1402	937 0205 303	Transistor RNC1404		R1401		Carbom (Chip) 1kohm 1/16W	VRS-CY1JB102J
Q1403	937 0205 206	Transistor RN2404		R1404		Carbom (Chip) 1kohm 1/16W	VRS-CY1JB102J
Q1404	937 0205 303	Transistor PNC1404		R1406,1407		Carbom (Chip) 3.3kohm 1/16W	VRS-CY1JB332J
Q1451	937 0205 400	Transistor RNC1407		R1408		Carbom (Chip) 100kohm 1/16W	VRS-CY1JB104J
Q1601	937 0104 307	Transistor 2SA1314C		R1409		Carbom (Chip) 1kohm 1/16W	VRS-CY1JB102J
Q1801	937 0104 307	Transistor 2SA1314C		R1412		Carbom (Chip) 100kohm 1/16W	VRS-CY1JB104J
Q1802,1803	937 0213 900	Transistor RN1406		R1413		Carbom (Chip) 3.3kohm 1/16W	VRS-CY1JB332J
Q1807	937 0104 307	Transistor 2SA1314C		R1414	937 9958 664	Carbom (Chip) 10kohm 1/16W	VRS-CY1JB103J
Q1820	937 0214 006	Transistor 2SA1162C		R1415		Carbom (Chip) 1kohm 1/16W	VRS-CY1JB102J
Q1821,1822	937 0205 400	Transistor RNC1407		R1416	937 9958 664	Carbom (Chip) 10kohm 1/16W	VRS-CY1JB103J
D1251,1252	937 0104 530	Diode SB0209CP-1		R1418		Carbom (Chip) 47ohm 1/16W	VRS-CY1JB470J
D1990	937 0104 514	Diode 1SS372		R1420		Carbom (Chip) 1kohm 1/16W	VRS-CY1JB102J
RESISTORS GROUP							
R1100		Carbom (Chip) 27ohm 1/8W	VRS-TQ2BB270J	R1422-1424		Carbom (Chip) 10kohm 1/16W	VRS-CY1JB103J
R1102		Carbom (Chip) 560ohm 1/16W	VRS-CY1JB561J	R1425		Carbom (Chip) 2.7kohm 1/16W	VRS-CY1JB272J
R1105		Carbom (Chip) 390kohm 1/16W	VRS-CY1JB394J	R1426		Carbom (Chip) 1kohm 1/16W	VRS-CY1JB102J
R1106	937 9958 664	Carbom (Chip) 10kohm 1/16W	VRS-CY1JB103J	R1427		Carbom (Chip) 4.7kohm 1/16W	VRS-CY1JB472J
R1107		Carbom (Chip) 1ohm 1/16W	VRS-CY1JB1R0J	R1428		Carbom (Chip) 1kohm 1/16W	VRS-CY1JB102J
R1150-1154	937 9958 729	Carbom (Chip) 22kohm 1/16W	VRS-CY1JB223J	R1429,1430		Carbom (Chip) 10kohm 1/16W	VRS-CY1JB103J
R1155		Carbom (Chip) 56kohm 1/16W	VRS-CY1JB563J	R1431		Carbom (Chip) 0ohm	VRS-CY1JB000J
R1166		Carbom (Chip) 1.2kohm 1/16W	VRS-CY1JB122J	R1452		Carbom (Chip) 3.3kohm 1/16W	VRS-CY1JB332J
				R1454		Carbom (Chip) 1kohm 1/16W	VRS-CY1JB102J
				R1456		Carbom (Chip) 1kohm 1/16W	VRS-CY1JB102J
				R1458		Carbom (Chip) 6.8kohm 1/16W	VRS-CY1JB682J
				R1459	937 9958 664	Carbom (Chip) 10kohm 1/16W	VRS-CY1JB103J
				R1460		Carbom (Chip) 6.8kohm 1/16W	VRS-CY1JB682J
				R1461	937 9958 664	Carbom (Chip) 10kohm 1/16W	VRS-CY1JB103J
				R1462		Carbom (Chip) 6.8kohm 1/16W	VRS-CY1JB682J
				R1463	937 9958 664	Carbom (Chip) 10kohm 1/16W	VRS-CY1JB103J
				R1464		Carbom (Chip) 220ohm 1/16W	VRS-CY1JB221J
				R1466		Carbom (Chip) 220ohm 1/16W	VRS-CY1JB221J
				R1471	937 9958 664	Carbom (Chip) 10kohm 1/16W	VRS-CY1JB103J
				R1472		Carbom (Chip) 47kohm 1/16W	VRS-CY1JB473J
				R1473		Carbom (Chip) 100kohm 1/16W	VRS-CY1JB104J
				R1474-1476		Carbom (Chip) 1kohm 1/16W	VRS-CY1JB102J
				R1477	937 9958 664	Carbom (Chip) 10kohm 1/16W	VRS-CY1JB103J
				R1609		Carbom (Chip) 1.5kohm 1/16W	VRS-CY1JB152J

Ref. No.	Part No.	Part Name	Remarks	Ref. No.	Part No.	Part Name	Remarks
R1610		Carbom (Chip) 30kohm 1/16W	VRS-CY1JB303D	R1965	937 9958 664	Carbom (Chip) 10kohm 1/16W	VRS-CY1JB103J
R1611		Carbom (Chip) 12kohm 1/16W	VRS-CY1JB123D	R1967		Carbom (Chip) 47ohm 1/16W	VRS-CY1JB470J
R1612		Carbom (Chip) 56kohm 1/16W	VRS-CY1JB563J	R1968		Carbom (Chip) 220ohm 1/16W	VRS-CY1JB221J
R1613		Carbom (Chip) 27kohm 1/16W	VRS-CY1JB273J	R1969		Carbom (Chip) 56ohm 1/8W	VRS-TQ2BB560J
R1614		Carbom (Chip) 18kohm 1/16W	VRS-CY1JB183D	R1973		Carbom (Chip) 6.8kohm 1/16W	VRS-CY1JB682J
R1617		Carbom (Chip) 47kohm 1/16W	VRS-CY1JB473J	R1974		Carbom (Chip) 220ohm 1/16W	VRS-CY1JB221J
R1620		Carbom (Chip) 0ohm	VRS-CY1JB000J	R1994		Carbom (Chip) 47ohm 1/16W	VRS-CY1JB470J
R1650	937 9958 664	Carbom (Chip) 10kohm 1/16W	VRS-CY1JB103J	R1995		Carbom (Chip) 0ohm	VRS-CY1JB000J
R1651		Carbom (Chip) 100kohm 1/16W	VRS-CY1JB104J	RC120		Carbom (Chip) 0ohm	VRS-CY1JB000J
R1652		Carbom (Chip) 10kohm 1/16W	VRS-CY1JB103J	LR190		Carbom (Chip) 22ohm 1/10W	VRS-TV2AB220J
R1653		Carbom (Chip) 100kohm 1/16W	VRS-CY1JB104J	J1405	937 9958 664	Carbom (Chip) 10kohm 1/16W	VRS-CY1JB103J
R1654		Carbom (Chip) 6.8kohm 1/16W	VRS-CY1JB682J	J1720	937 9955 201	Carbom (Chip) 0ohm	VRS-TV2AB000J
R1655	937 9958 732	Carbom (Chip) 120kohm 1/16W	VRS-CY1JB124J	J1730		Carbom (Chip) 0ohm	VRS-CY1JB000J
R1656		Carbom (Chip) 6.8kohm 1/16W	VRS-CY1JB682J	J1920		Carbom (Chip) 0ohm	VRS-CY1JB000J
R1657	937 9958 732	Carbom (Chip) 120kohm 1/16W	VRS-CY1JB124J	J1922		Carbom (Chip) 0ohm	VRS-CY1JB000J
R1658		Carbom (Chip) 15kohm 1/16W	VRS-CY1JB153J	J1950		Carbom (Chip) 0ohm	VRS-CY1JB000J
R1659		Carbom (Chip) 82kohm 1/16W	VRS-CY1JB823J	J1963		Carbom (Chip) 0ohm	VRS-CY1JB000J
R1660		Carbom (Chip) 15kohm 1/16W	VRS-CY1JB153J				
R1661		Carbom (Chip) 82kohm 1/16W	VRS-CY1JB823J	CAPACITORS GROUP			
R1662	937 9958 664	Carbom (Chip) 10kohm 1/16W	VRS-CY1JB103J	C1101		Ceramic (Chip) 1μF/6.3V	VCKYTV0JB105K
R1663		Carbom (Chip) 62kohm 1/16W	VRS-CY1JB623J	C1102		Ceramic (Chip) 1μF/6.3V	VCKYTV0JB105K
R1664	937 9958 664	Carbom (Chip) 10kohm 1/16W	VRS-CY1JB103J	C1103	937 9958 004	Ceramic (Chip) 1μF/16V	VCKYTV1CF105Z
R1665		Carbom (Chip) 62kohm 1/16W	VRS-CY1JB623J	C1104		Ceramic (Chip) 0.027μF/50V	VCKYTV1HB273K
R1666,1667	937 9958 729	Carbom (Chip) 22kohm 1/16W	VRS-CY1JB223J	C1105		Ceramic (Chip) 1μF/6.3V	VCKYTV0JB105K
R1668,1669		Carbom (Chip) 6.8kohm 1/16W	VRS-CY1JB682J	C1106	937 9955 845	Ceramic (Chip) 0.47μF/16V	VCKYTV1CB474K
R1708		Carbom (Chip) 6.8kohm 1/16W	VRS-CY1JB682J	C1107	937 9955 887	Ceramic (Chip) 0.0047μF/50V	VCKYTV1HB472K
R1733		Carbom (Chip) 1kohm 1/16W	VRS-CY1JB102J	C1109		Ceramic (Chip) 1μF/6.3V	VCKYTV0JB105K
R1758,1759		Carbom (Chip) 1kohm 1/16W	VRS-CY1JB102J	C1110		Ceramic (Chip) 0.47μF/16V	VCKYTV1CB474K
R1801		Carbom (Chip) 1.8kohm 1/16W	VRS-CY1JB182J	C1111		Ceramic (Chip) 0.015μF/50V	VCKYTV1HB153K
R1802		Carbom (Chip) 270ohm 1/16W	VRS-CY1JB271J	C1112-1116		Ceramic (Chip) 270pF/50V	VCCCCY1HH271J
R1804		Carbom (Chip) 220kohm 1/16W	VRS-CY1JB224J	C1121	937 9958 004	Ceramic (Chip) 1μF/16V	VCKYTV1CF105Z
R1805		Carbom (Chip) 100kohm 1/16W	VRS-CY1JB104J	C1145	937 9958 211	Ceramic (Chip) 0.033μF/16V	VCKYCY1CB333K
R1808		Carbom (Chip) 27kohm 1/16W	VRS-CY1JB273J	C1202,1203	937 9958 004	Ceramic (Chip) 1μF/16V	VCKYTV1CF105Z
R1809		Carbom (Chip) 390ohm 1/16W	VRS-CY1JB391J	C1204,1205	937 9958 114	Ceramic (Chip) 12pF/50V	VCCCCY1HH120J
R1820,1821		Carbom (Chip) 1ohm 1/10W	VRS-TY2AB1R0J	C1206,1207		Ceramic (Chip) 1μF/16V	VCKYTV1CF105Z
R1827		Carbom (Chip) 270ohm 1/16W	VRS-CY1JB271J	C1208	937 9958 224	Ceramic (Chip) 0.047μF/16V	VCKYCY1CB473K
R1901	937 9955 421	Carbom (Chip) 470ohm 1/10W	VRS-TY2AB471J	C1209-1211		Ceramic (Chip) 1μF/16V	VCKYTV1CF105Z
R1902		Carbom (Chip) 1.8kohm 1/10W	VRS-TY2AB182J	C1251		Ceramic (Chip) 0.027μF/16V	VCKYCY1CB273K
R1903,1904		Carbom (Chip) 820ohm 1/10W	VRS-TY2AB821J	C1252		Ceramic (Chip) 120pF/50V	VCCCCY1HH121J
R1927		Carbom (Chip) 22ohm 1/10W	VRS-TY2AB220J	C1254		Ceramic (Chip) 10μF/10V	RC-KZ0002AWZZ
R1939		Carbom (Chip) 1kohm 1/16W	VRS-CY1JB102J	C1255		Ceramic (Chip) 4.7μF/10V	RC-KZ0003AWZZ
R1940		Carbom (Chip) 220ohm 1/16W	VRS-CY1JB221J	C1401,1402		Ceramic (Chip) 0.047μF/16V	VCKYCY1CB473K
R1947		Carbom (Chip) 47ohm 1/10W	VRS-TY2AB470J	C1403		Ceramic (Chip) 680pF/50V	VCKYCY1HB681K
R1951		Carbom (Chip) 0ohm	VRS-CY1JB000J	C1405	937 9958 266	Ceramic (Chip) 0.1μF/25V	VCKYCY1EF104Z
R1952,1953		Carbom (Chip) 47ohm 1/16W	VRS-CY1JB470J				
R1961		Carbom (Chip) 100ohm 1/16W	VRS-CY1JB101J				
R1962		Carbom (Chip) 220kohm 1/16W	VRS-CY1JB224J				
R1963		Carbom (Chip) 1.5kohm 1/16W	VRS-CY1JB152J				
R1964		Carbom (Chip) 6.8kohm 1/16W	VRS-CY1JB682J				

Ref. No.	Part No.	Part Name	Remarks	Ref. No.	Part No.	Part Name	Remarks	Q'ty
C1406		Ceramic (Chip) 1μF/16V	VCKYTV1CF105Z	OTHER PARTS GROUP				
C1407	937 9958 127	Ceramic (Chip) 0.022μF/ 50V	VCKYCY1CB223K	L1101	937 0214 103	Coil 10μH		1
C1412		Ceramic (Chip) 680pF/50V	VCKYCY1HB681K	L1102	937 0214 200	Coil 0.47μH		1
C1421-1424	937 9958 127	Ceramic (Chip) 0.022μF/16V	VCKYCY1CB223K	L1201	937 0214 200	Coil 0.47μH		1
C1425	937 9958 224	Ceramic (Chip) 0.047μF/16V	VCKYCY1CB473K	L1203	937 0214 307	Coil 4.7μH		1
C1601,0602	937 9958 004	Ceramic (Chip) 1μF/16V	VCKYTV1CF105Z	L1251	937 0214 404	Coil 47μH		1
C1604		Ceramic (Chip) 56pF/50V	VCCCCY1HH560J	L1601	937 0214 501	Coil 1μH		1
C1605	937 9958 295	Electrolytic 100μF/10V	VCEAPS107AF1A	L1950	937 0214 501	Coil 1μH		1
C1609	937 9955 120	Ceramic (Chip) 1μF/16V	VCKYTV1CF105Z	XL1201	937 0214 608	Crystal 33.8688MHz		1
C1610		Ceramic (Chip) 10μF/10V	RC-KZ0002AWZZ	CN1101	937 0214 802	23P plug		1
C1631	937 9958 004	Ceramic (Chip) 1μF/16V	VCKYTV1CF105Z	CN1252	937 0148 318	2P plug		1
C1650-1653	937 9958 350	Ceramic (Chip) 820pF/50V	VCCSCY1HL821J	CN1601	937 0214 815	5P plug		1
C1654,1655		Ceramic (Chip) 0.015μF/25V	VCKYCY1EB153K	CN1602	937 0214 828	2P plug		1
C1656,1657		Ceramic (Chip) 0.0056μF/50V	VCKYCY1HB562K	CN1603	937 0214 831	2P plug		1
C1661	937 9958 295	Electrolytic 100μF/10V	VCEAPS107AF1A	CN1604	937 0214 844	2P plug		1
C1724	937 9958 486	Ceramic (Chip) 22pF/50V	VCCCCY1HH220J	CN1901	937 0214 857	5P socket		1
C1801	937 9958 088	Ceramic (Chip) 2.2μF/16V	VCKYTQ1CF225Z	CN1902	937 0214 860	24P socket		1
C1802	937 9958 295	Electrolytic 100μF/10V	VCEAPS107AF1A	CN1904	937 0203 509	4P plug		1
C1803	937 9958 088	Ceramic (Chip) 2.2μF/16V	VCKYTQ1CF225Z	CW1901	937 0214 909	5P connector Ass'y		1
C1805	937 9958 004	Ceramic (Chip) 1μF/16V	VCKYTV1CF105Z	CW1903	937 0215 005	2P connector Ass'y		1
C1806		Ceramic (Chip) 10μF/10V	RC-KZ0002AWZZ	M901	937 0215 102	Spindle motor Ass'y		1
C1807		Electrolytic 220μF/4V	VCEAPS227AF0G	M902	937 0215 209	Feed motor Ass'y		1
C1913	937 9958 486	Ceramic (Chip) 22pF/50V	VCCCCY1HH220J	M903	937 0215 306	Loading motor Ass'y		1
C1927	937 9958 224	Ceramic (Chip) 0.047μF/16V	VCKYCY1CB473K	SW1952	937 0215 403	Push switch		1
C1951	937 9958 224	Ceramic (Chip) 0.047μF/16V	VCKYCY1CB473K	SW1953	937 0152 207	Push switch		1
C1952	937 9958 499	Ceramic (Chip) 0.01μF/16V	VCKYCY1CB103K	SW1954,1955	937 0215 500	Push switch		2
C1953	937 9958 253	Ceramic (Chip) 0.47μF/16V	VCKYCY1CB472K	SW1956	937 0215 607	Push switch		1
C1954	937 9958 509	Ceramic (Chip) 15pF/50V	VCCCCY1HH150J					
C1955	937 9958 224	Ceramic (Chip) 0.047μF/16V	VCKYCY1CB473K					
C1956	937 9958 512	Electrolytic 47μF/6.3V	VCEAPS476AF0J					
C1957	937 9958 525	Electrolytic 100μF/6.3V	VCEAPS107AF0J					
C1958	937 9958 224	Ceramic (Chip) 0.047μF/16V	VCKYCY1CB473K					
C1964	937 9958 376	Ceramic (Chip) 1000pF/16V	VCKYCY1HB102K					
C1990		Ceramic (Chip) 1μF/6.3V	VCKYTV0JB105K					
C1991		Ceramic (Chip) 10μF/10V	RC-KZ0002AWZZ					
C1992	937 9958 266	Ceramic (Chip) 0.1μF/25V	VCKYCY1EF104Z					
JC171	937 9955 874	Ceramic (Chip) 22pF/50V	VCCCTV1HH220J					
JC196	937 9955 874	Ceramic (Chip) 22pF/50V	VCCCTV1HH220J					

MDM97 MD MECHANISM EXPLODED VIEW

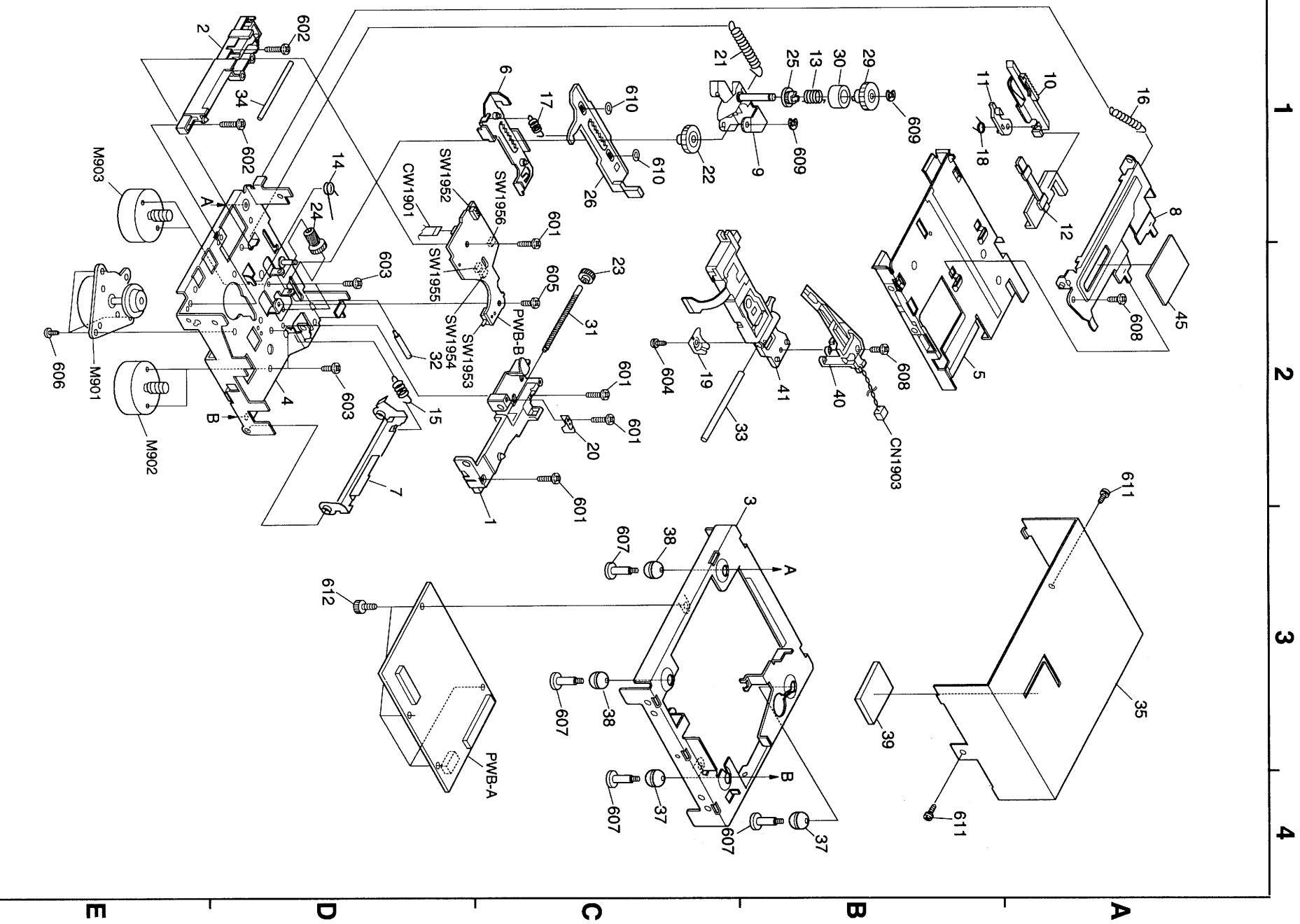

MDM97 MD MECHANISM PARTS LIST OF EXPLODED VIEW

Ref. No.	Part No.	Part Name	Remarks	Qty
1	937 0215 704	MD guide bracket (A)		1
2	937 0215 801	MD guide bracket (A)		1
3	937 0215 908	Base frame		1
4	937 0216 004	Drive chassis		1
5	937 0216 101	Cartridge holder		1
6	937 0216 208	Cam plate lever		1
7	937 0216 305	Head arm up lever		1
8	937 0216 402	Holder arm		1
9	937 0216 509	Roller arm lever		1
10	937 0216 606	Guide lever		1
11	937 0216 703	Catch lever		1
12	937 0216 800	Slider lever		1
13	937 0216 907	Roller holder spring		1
14	937 0216 910	Spring		1
15	937 0160 202	Shaft arm spring		1
16	937 0162 006	Holder arm spring		1
17	937 0159 705	Lack spring		1
18	379 0180 509	Catch spring		1
19	937 0217 003	Drive grip spring (A)		1
20	937 0216 923	Drive shaft spring		1
21	937 0161 502	Roller arm spring		1
22	937 0217 100	Loading gear (B)		1
23	937 0217 207	Drive gear		1
24	937 0217 304	Loading gear (A)		1
25	937 0217 401	Roller gear		1
26	937 0217 508	Lack gear		1
29	937 0217 605	Roller holder		1
30	937 0217 702	Roller		1
31	937 0217 809	Drive shaft		1
32	937 0217 906	Loading gear shaft		1
33	937 0159 501	Pickup slide shaft		1
34	937 0160 406	Pickup guide shaft		1
35	937 0218 002	Cover		1
37	937 0163 005	Cushion (A)		2
38	937 0163 102	Cushion (B)		2
39	937 0218 109	Head cushion		1
40	937 0218 206	Magnetic head		1
41	937 0218 303	Optical pickup unit		1
M901	937 0215 102	MD Spindle motor Assy		1
M902	937 0215 209	MD Feed motor Assy		1
M903	937 0215 306	MD Loading motor Assy		1
SW1952	937 0215 403	Push switch		1
SW1953	937 0152 207	Push switch		1
SW1954	937 0215 500	Push switch		1
SW1955	937 0215 500	Push switch		1
SW1956	937 0215 607	Push switch		1
CW1901	937 0214 909	SP connector Assy		1

Ref. No.	Part No.	Part Name	Remarks	Qty
SCREWS & NUTS				
601	937 0218 400	Screw Φ 1.7x9.5 mm		4
602	937 0218 413	Screw Φ 1.7x7.5 mm		2
603	937 0218 426	Screw Φ 1.7x2 mm		4
604	937 0105 924	Screw Φ 1.4x2.2 mm		2
605	937 0161 609	Screw Φ 1.7x3 mm		1
606	937 0161 007	Screw Φ 1.7x2.5 mm		3
607	937 0163 607	Screw Φ 1.7x8.9 mm		4
608	937 0161 900	Screw Φ 1.7x5 mm		2
609	937 0161 405	Washer Φ 1.5x Φ 3.2x0.5 mm		2
610	937 0159 909	Washer Φ 1.2x Φ 3x0.25 mm		2
611	937 0163 403	Screw Φ 2x4 mm		2
612	937 0163 500	Screw Φ 1.7x3 mm		4

EXPLODED VIEW

1 2 3 4 5 6 7 8

WARNING:
Parts marked with this symbol Δ have critical characteristics.
Use ONLY replacement parts recommended by the manufacturer.

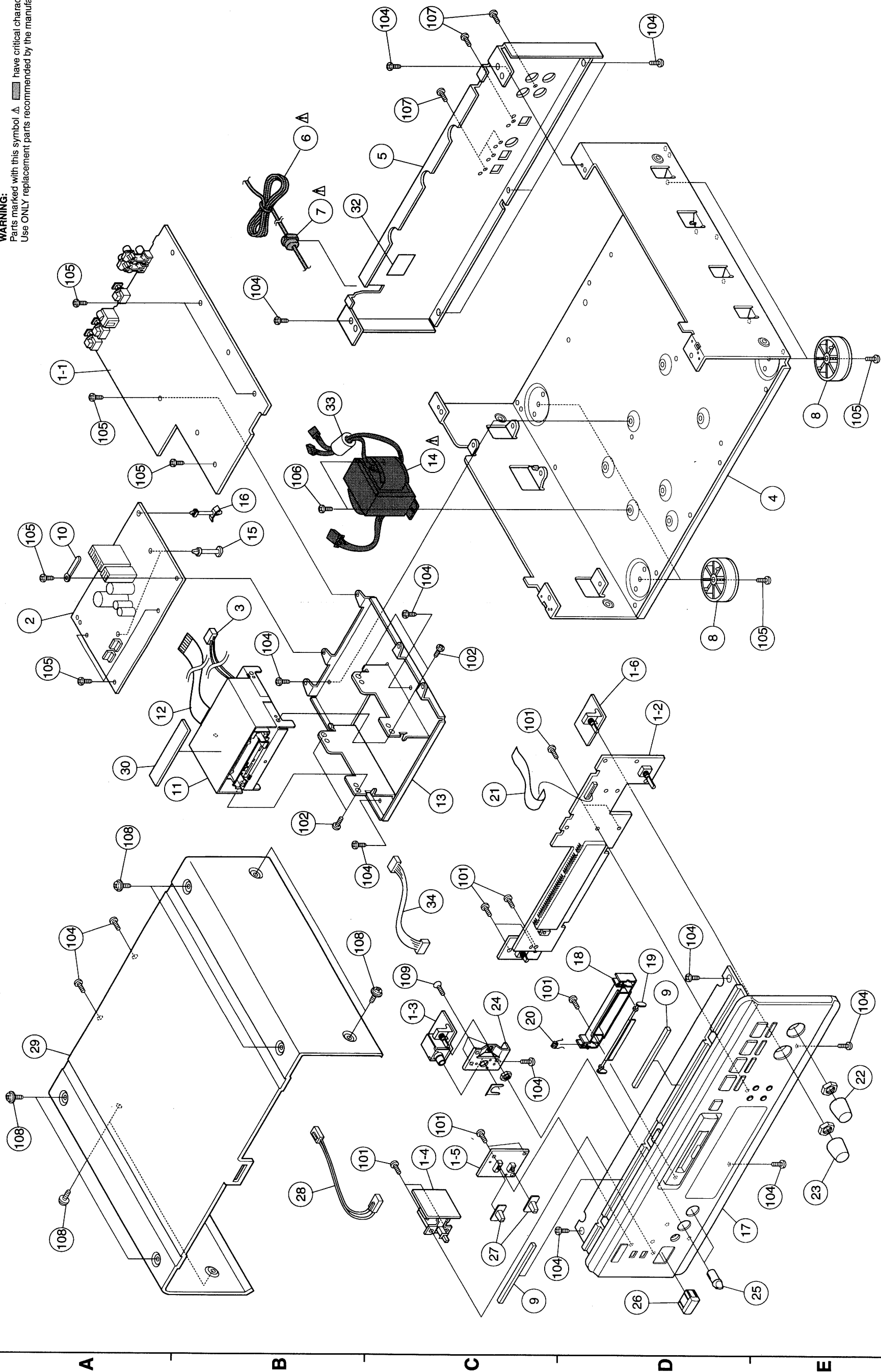

PARTS LIST OF EXPLODED VIEW

Ref. No.	Part No.	Part Name	Remarks	Qty
1	1U-3073A	Main P.W.B. Unit Assy		1
1-1	1U-3073-1	Main unit		(1)
1-2	1U-3073-2	Display unit		(1)
1-3	1U-3073-3	Head phone unit		(1)
1-4	1U-3073-4	Power switch unit		(1)
1-5	1U-3073-5	Timer unit		(1)
1-6	1U-3073-6	REC VR unit		(1)
2	1U-3074A	Power P.W.B. Unit Assy	Except U.S.A./Canada models	1
2-1	1U-3074-1	Power unit	Canada models	(1)
3	203 6504 002	4P shield connector cord		1
4	411 1371 200	Chassis		1
5	Note	Rear panel		1
6	Note	AC cord with connector		1
7	445 0056 008	Card bush		1
8	104 0194 205	Foot ass'y		4
9	461 0501 005	Rubber sheet		2
10	445 0048 016	Cord holder	L=50	1
11	337 0053 001	MD mecha unit (MDM-97)		1
12	009 0146 013	24P FFC cable shield		1
13	412 4285 105	Mecha chassis		1
14	Note	Power trans.		1
15	412 2814 073	Card spacer	L=18	2
16	409 0052 006	Holder (A)		1
17	144 2572 409	Front panel ass'y	Gold model	1
17	Note	Front panel ass'y	Black model	1
18	441 1815 107	Door holder		1
19	146 1653 008	Door	Gold model	1
19	146 1653 040	Door	Black model	1
20	463 0841 004	Door spring		1
21	009 0105 009	25P FFC cable		1
22	112 0779 003	Knob (maru)	Gold model	1
22	112 0779 045	Knob (maru)	Black model	1
23	112 0779 016	Knob (maru)	Gold model	1
23	112 0812 009	Knob (maru)	Black model	1
24	412 4286 104	Head phone bracket		1
25	112 0811 000	Knob (Fuji)	Gold model	2
25	112 0811 013	Knob (Fuji)	Black model	2
26	113 9213 084	Power knob (P) ass'y	Gold model	1
26	113 9213 000	Power knob (P) ass'y	Black model	1
27	113 1797 003	Slide knob	Gold model	2
27	113 1797 016	Slide knob	Black model	2
28	203 5132 051	3P VH-VH connector cord		1
29	102 9048 275	Top cover	Gold model	1
29	102 9048 262	Top cover	Black model	1
30	513 2065 002	E2 laser caution	Europe/U.K. Asia models	1
32	513 2404 058	Fuse caution label	U.S.A./Canada models	1
33	342 0020 007	Ferrite core		1
34	203 8488 003	SF PH-PH connector cord		1

Ref. No.	Part No.	Part Name	Remarks	Qty
SCREWS & NUTS				
101	473 7508 017	Screw 3X10 CBTS(P)-B		11
102	471 3303 016	Screw 3X6 CBS-Z		4
103	471 3304 015	Screw 3X8 CBS-Z		3
104	473 7015 018	Screw 3X8 CBTS(S)-B		15
105	473 7002 018	Screw 3X8 CBTS(S)-Z		12
106	473 7004 016	Screw 4X6 CBTS(S)-Z		2
107	477 0064 107	Fixing screw		5
108	477 0263 018	3P swelling screw	Gold model	8
108	477 0263 005	3P swelling screw	Black model	8
109	473 7511 004	Screw 3X10 CBTS(P)-B		3

Ref. No.	Part No.	Part Name	Remarks	Qty
PACKING & ACCESSORIES (Not included EXPLODED VIEW)				
201	Note	Rating sheet		1
202	504 0168 004	AC protect sheet	U.K. model only	1
203	513 1381 004	Manufacture date label	U.S.A./Canada models	1
204	504 0092 060	Stylen paper		1
205	505 0131 076	Cabinet cover		1
206	503 1269 103	Cushion		2
208	501 1977 075	Carton case		1
209	513 9111 001	Color label (gold)	Europe/Asia	2
210	517 1340 005	E2 POS label	Gold models	1
210	517 1340 018	E2 POS label	Europe gold model only	1
210	517 1316 013	UPC label	Europe black model only	1
210	517 1342 061	EK POS label	U.K. model only	1
211	513 1389 006	Control card	U.S.A./Canada models	1
212	505 0038 030	Poly. cover		1
213	Note	Inst. manual		1
214	515 0671 601	S.S. list (EX)		1
215	515 0690 307	DEL warranty home	U.S.A./Canada models	1
216	203 2360 004	2P pin cord		2
217	351 0001 017	Optical cable		1
218	399 0473 003	Remicon	FC-270	1

ADDEMDUM PARTS LIST
PARTS LIST OF EXPLODED VIEW

Ref. No.	Part Name	Part No.			
		U.S.A./Canada	Europe	U.K.	Asia
5	Rear panel	105 1231 047	105 1231 034	105 1231 050	105 1231 034
6	AC card with connector	208 2110 004	206 2889 106	208 2128 009	206 2889 106
14	Power trans.	233 6241 007	233 6242 006	233 6242 006	233 6242 006
17	Front panel ass'y	144 2572 441	144 2572 412	144 2572 412	—
201	Rating sheet	513 1581 011	513 2689 022	513 2689 022	513 2689 035
213	Inst. manual	511 3213 006	511 3214 005	511 3214 005	511 3216 003

WIRING DIAGRAM

1 2 3 4 5 6 7 8

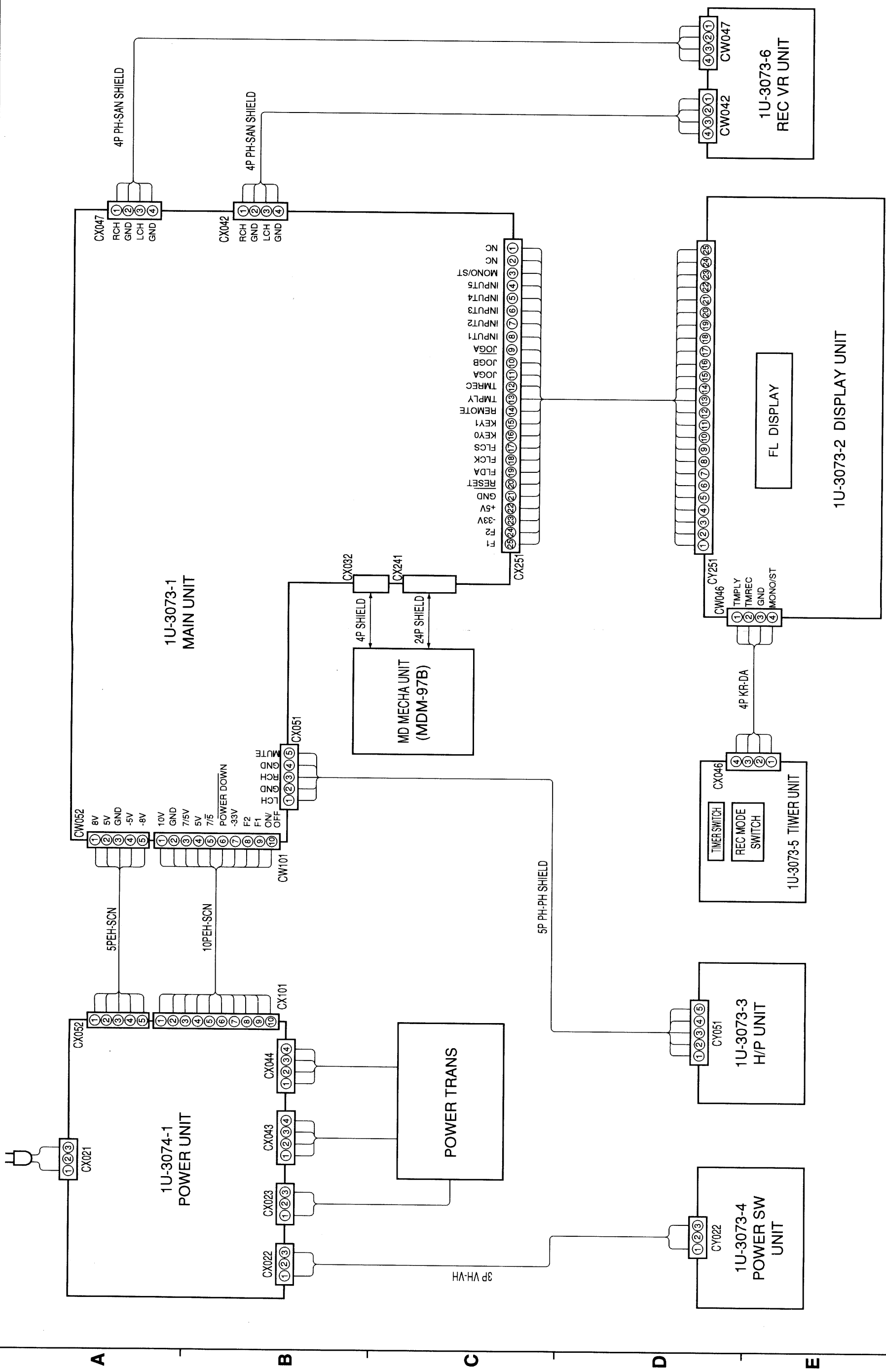

SCHEMATIC DIAGRAM (1/4)

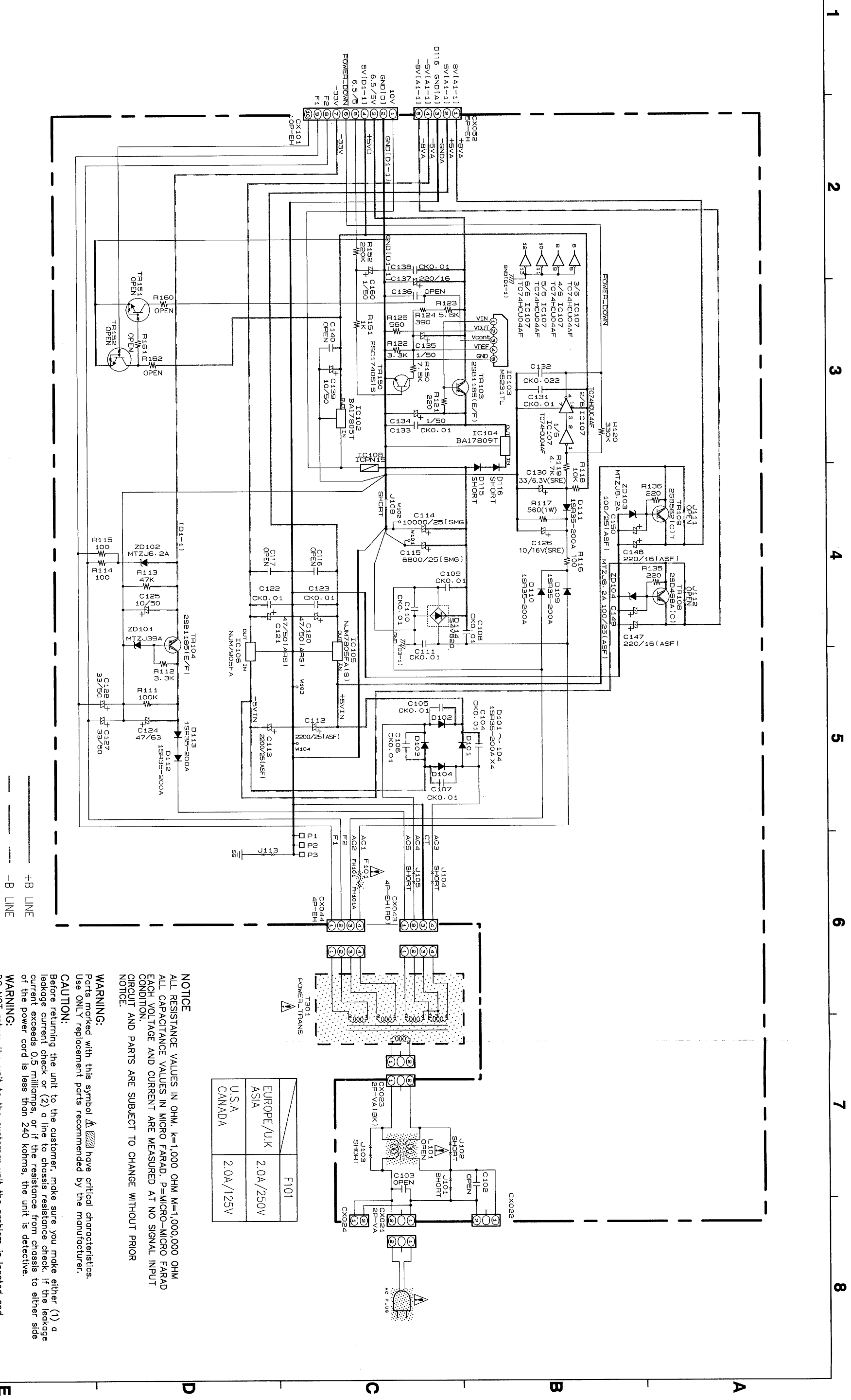

EUROPE/U.K.	F101
ASIA	2.0A/250V
U.S.A.	2.0A/125V
CANADA	

NOTICE
 ALL RESISTANCE VALUES IN OHM. K=1,000 OHM M=1,000,000 OHM
 ALL CAPACITANCE VALUES IN MICRO FARAD. P=MICRO-MICRO FARAD
 EACH VOLTAGE AND CURRENT ARE MEASURED AT NO SIGNAL INPUT
 CONDITION.
 CIRCUIT AND PARTS ARE SUBJECT TO CHANGE WITHOUT PRIOR
 NOTICE.

WARNING:
 Parts marked with this symbol  have critical characteristics.
 Use ONLY replacement parts recommended by the manufacturer.

CAUTION:
 Before returning the unit to the customer, make sure you make either (1) a leakage current check or (2) a line to chassis resistance check. If the leakage current exceeds 0.5 milliamperes, or if the resistance from chassis to either side of the power cord is less than 240 kohms, the unit is defective.

WARNING:
 DO NOT return the unit to the customer until the problem is located and corrected.

SCHEMATIC DIAGRAM (2/4)

1 2 3 4 5 6 7 8

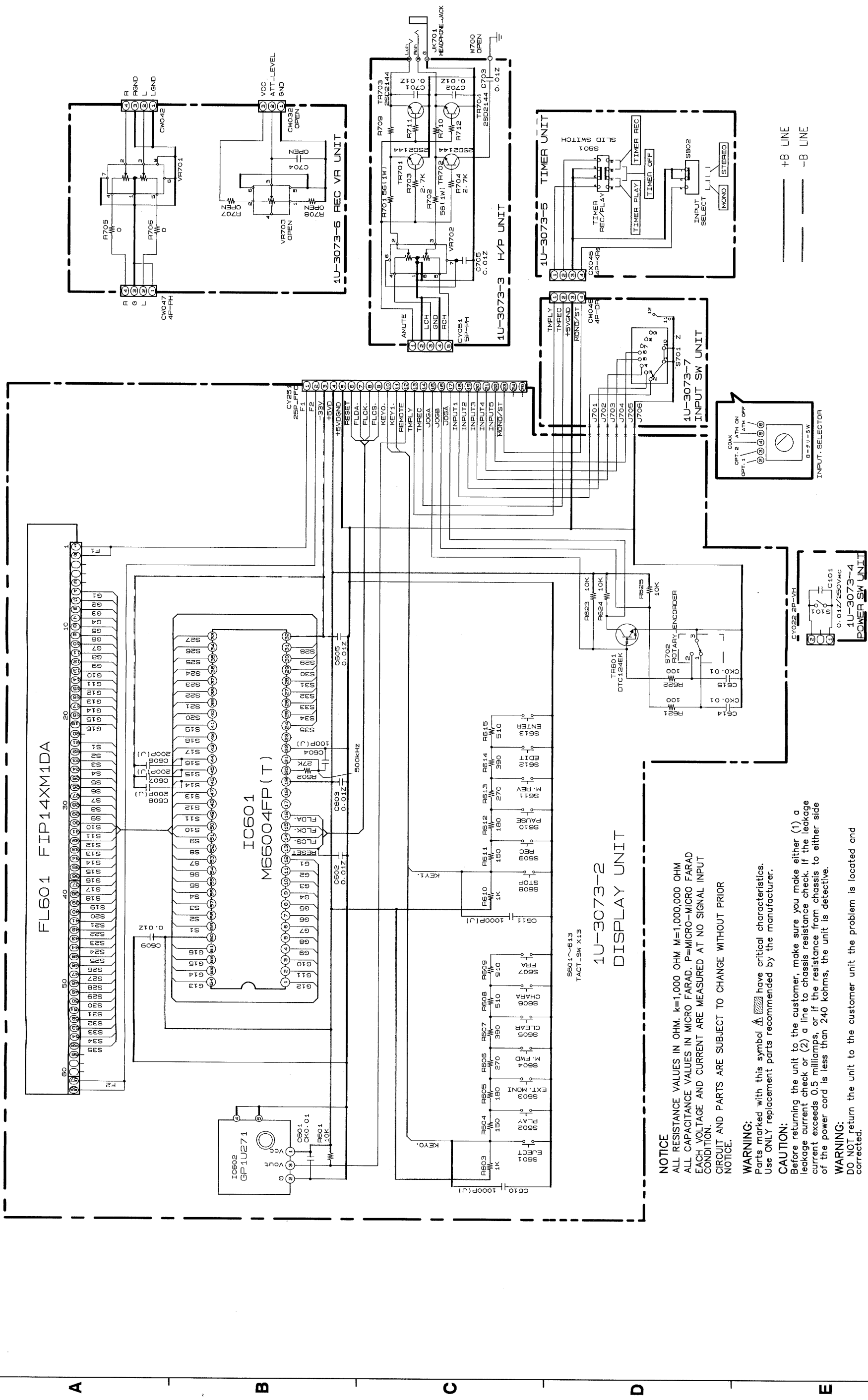

NOTICE
 ALL RESISTANCE VALUES IN OHM. K=1,000 OHM M=1,000,000 OHM
 ALL CAPACITANCE VALUES IN MICRO FARAD. P=MICRO-MICRO FARAD
 EACH VOLTAGE AND CURRENT ARE MEASURED AT NO SIGNAL INPUT
 CONDITION.
 CIRCUIT AND PARTS ARE SUBJECT TO CHANGE WITHOUT PRIOR
 NOTICE.

WARNING:
 Parts marked with this symbol  have critical characteristics.
 Use ONLY replacement parts recommended by the manufacturer.

CAUTION:
 Before returning the unit to the customer, make sure you make either (1) a leakage current check or (2) a line to chassis resistance check. If the leakage current exceeds 0.5 milliamperes, or if the resistance from chassis to either side of the power cord is less than 240 kohms, the unit is defective.

WARNING:
 DO NOT return the unit to the customer until the problem is located and corrected.